

Decoding from language models

CS685 Spring 2023

Advanced Natural Language Processing

Mohit Iyyer

College of Information and Computer Sciences
University of Massachusetts Amherst

Decoding

- Given a pretrained LM and a prefix, how do we generate the most probable continuation (or *any* probable continuation) of that prefix?

- More concretely, how do we find

$$\arg \max \prod_i^L p(w_i | w_1, w_2, \dots, w_{i-1}, \text{prefix})$$

- Can we enumerate all possible generations given the prefix and then choose the one with the highest probability?

easiest option: **greedy decoding**

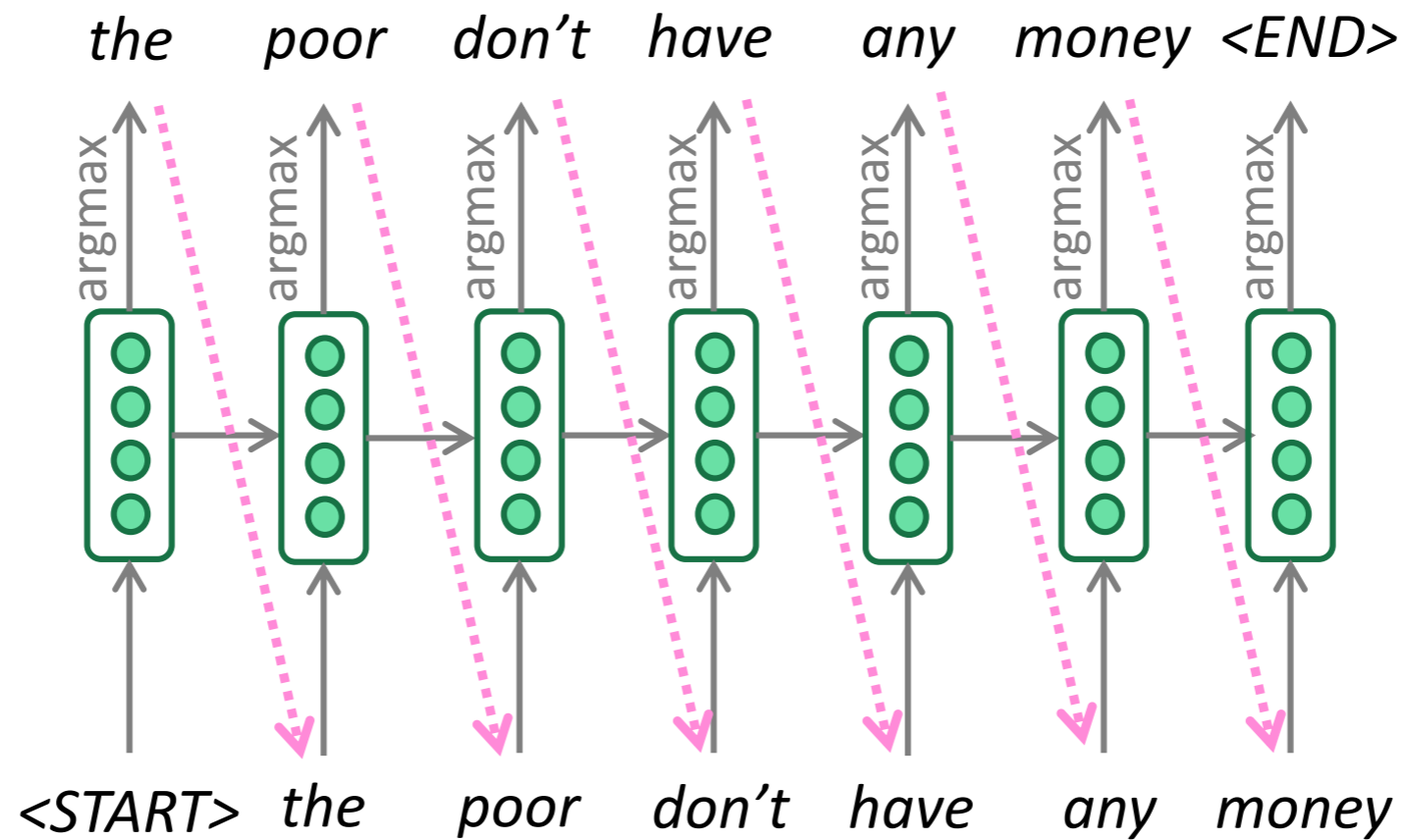

issues?

Beam search

- in greedy decoding, we cannot go back and revise previous decisions!
 - *les pauvres sont démunis (the poor don't have any money)*
 - → *the _____*
 - → *the poor _____*
 - → *the poor **are** _____*
- fundamental idea of beam search: explore several different hypotheses instead of just a single one
 - keep track of k most probable partial translations at each decoder step instead of just one!
the beam size k is usually 5-10

Beam search decoding: example

Beam size = 2

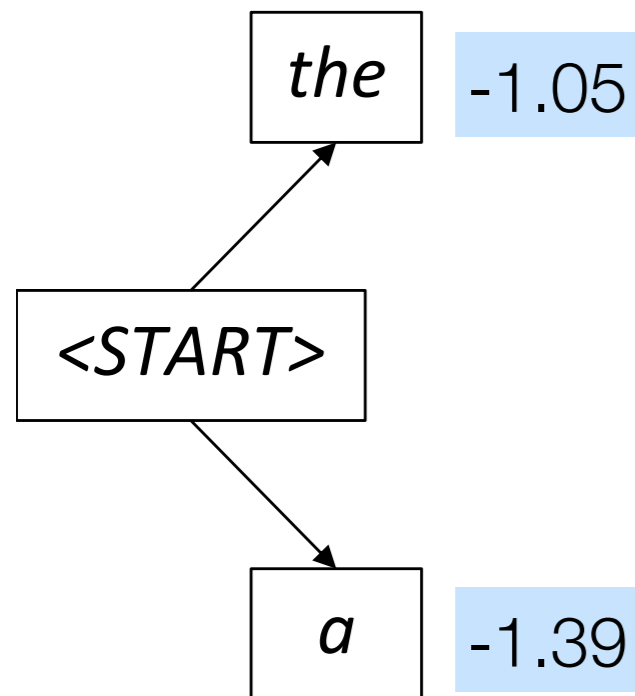

Beam search decoding: example

Beam size = 2

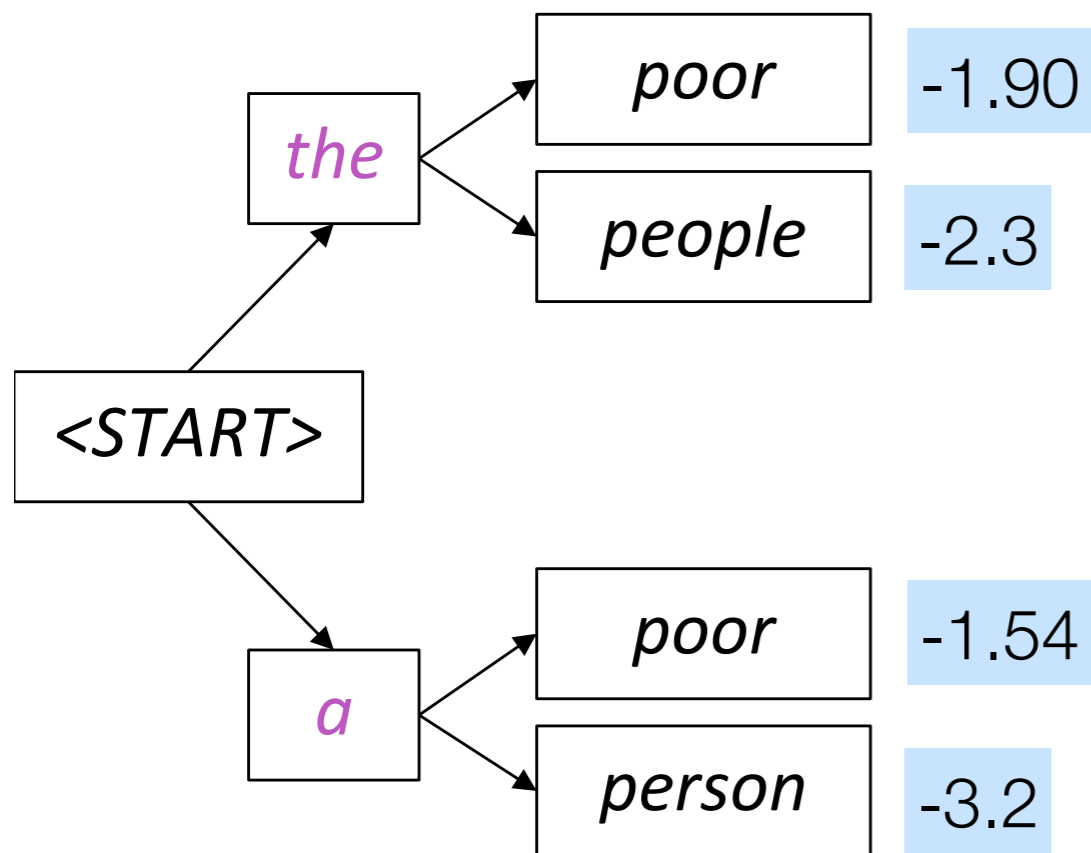

Beam search decoding: example

Beam size = 2

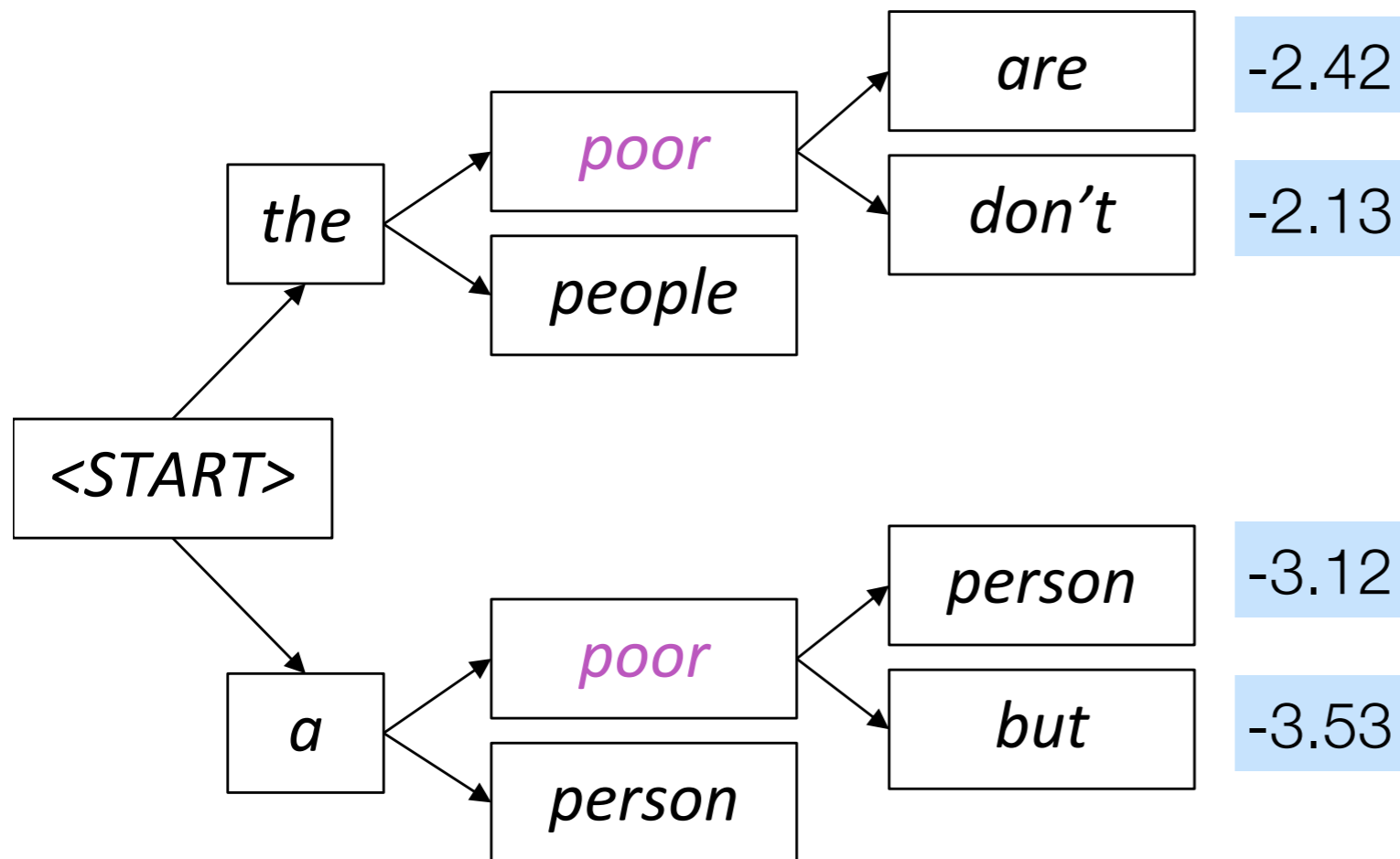

Beam search decoding: example

Beam size = 2

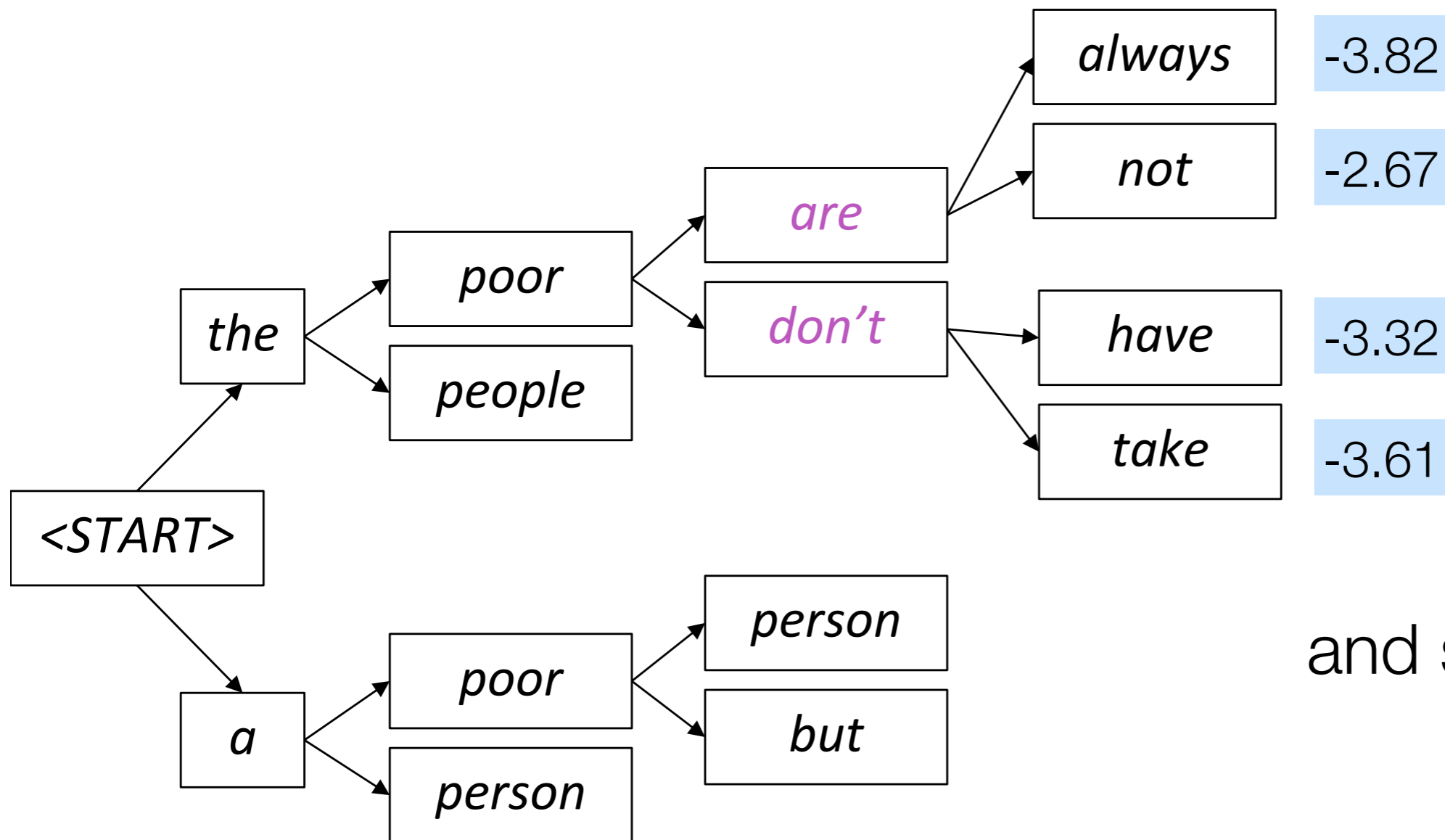

and so on...

Beam search decoding: example

Beam size = 2

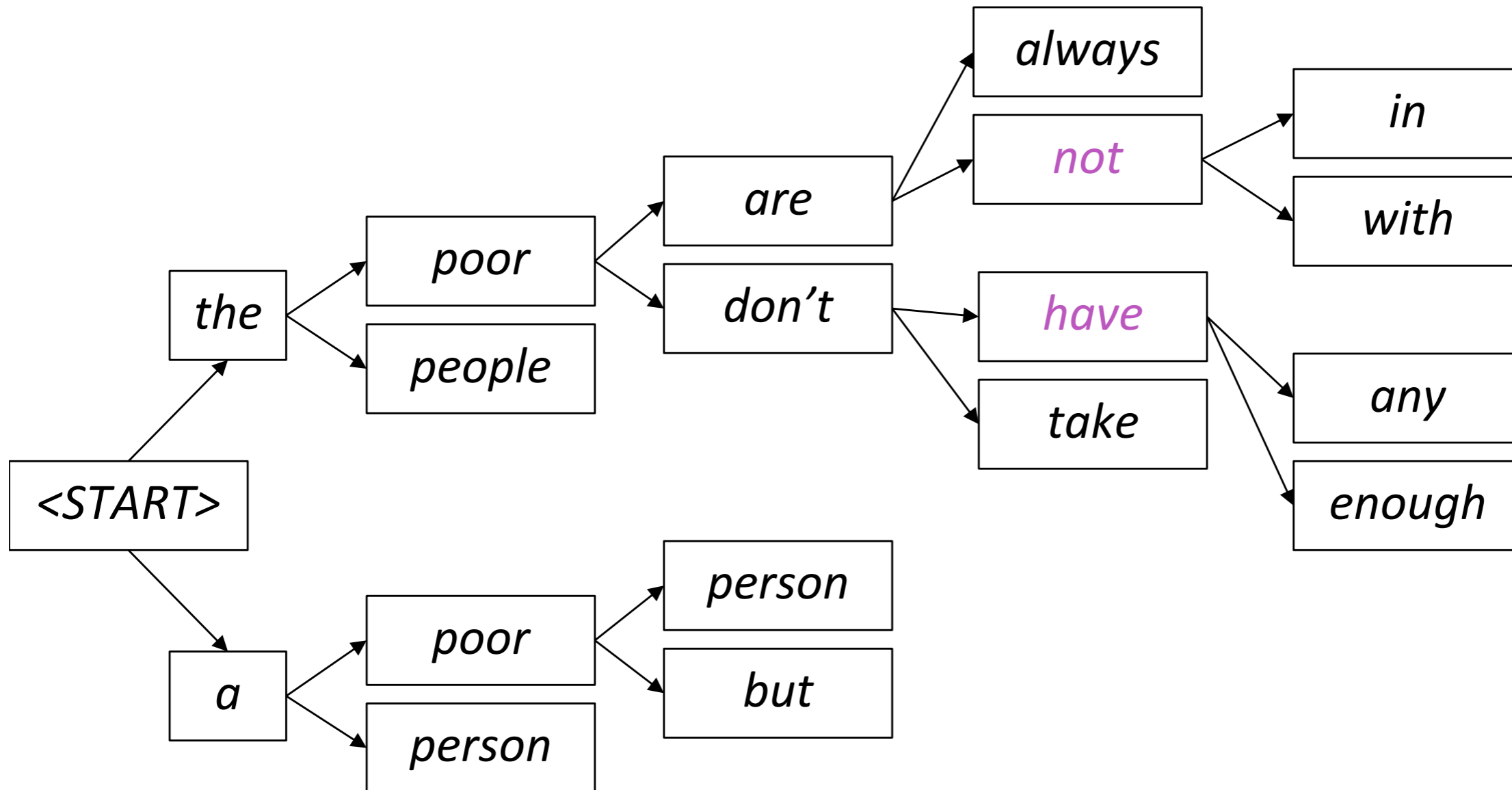

Beam search decoding: example

Beam size = 2

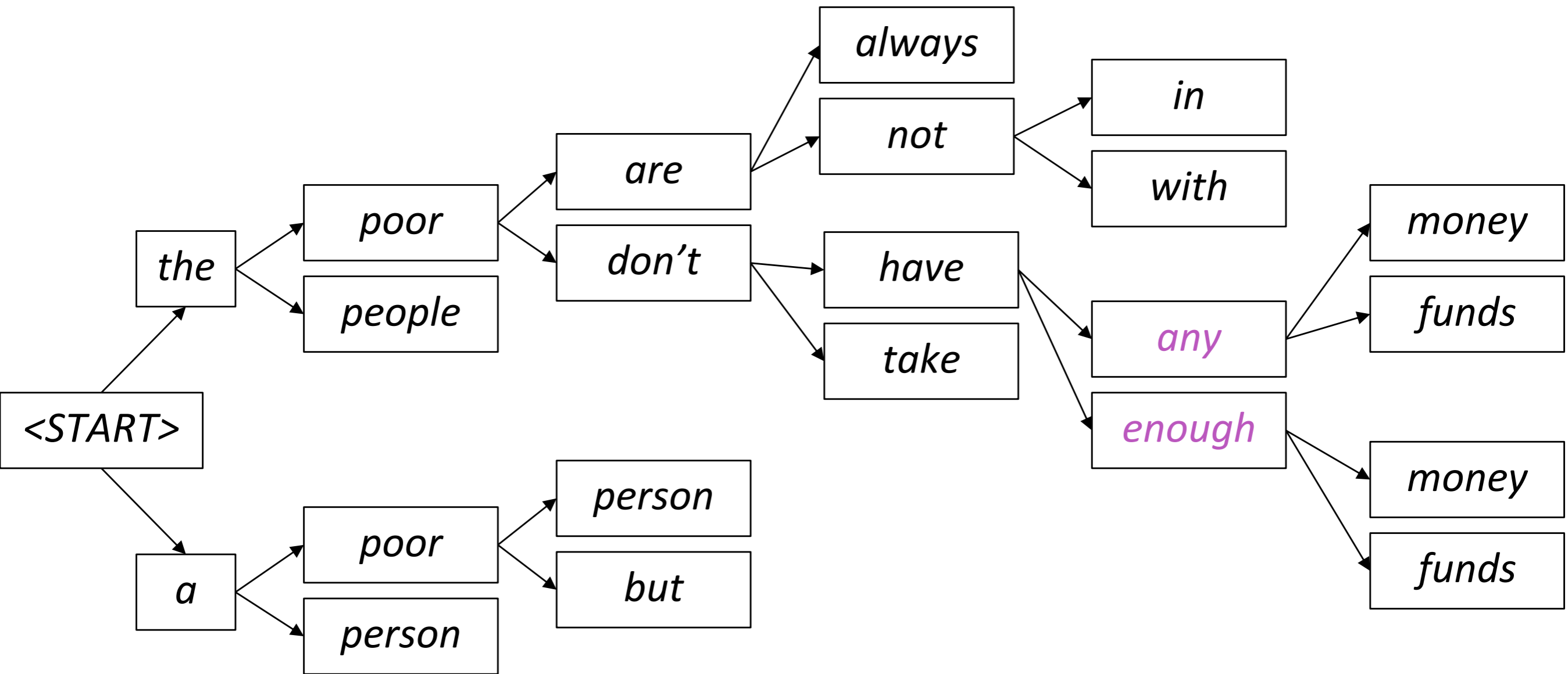

Beam search decoding: example

Beam size = 2

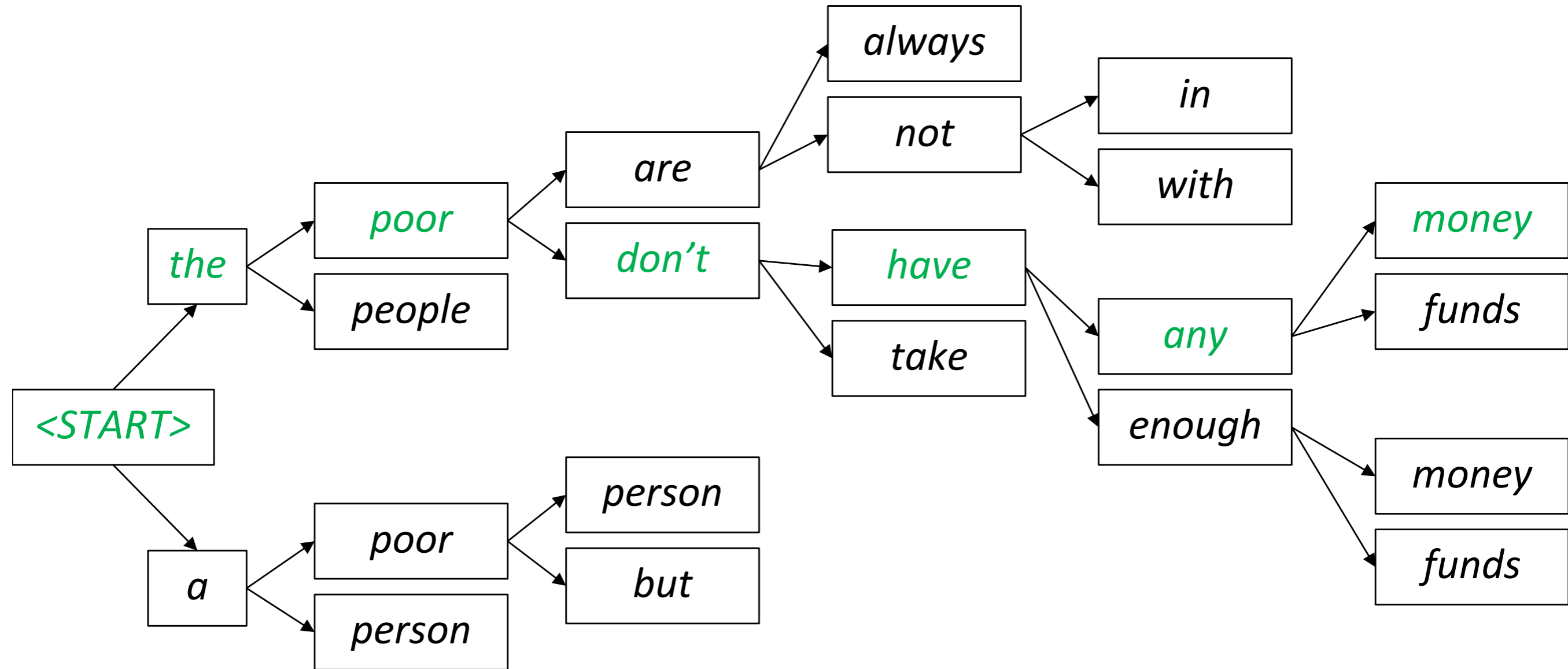

Does beam search always return the most probable continuation of the prefix?

What are the termination conditions of beam search?

What's the effect of changing beam size k ?

- Small k has similar problems to greedy decoding ($k=1$)
 - Ungrammatical, unnatural, nonsensical, incorrect
- Larger k means you consider more hypotheses
 - Increasing k reduces some of the problems above
 - Larger k is more computationally expensive
 - But increasing k can introduce other problems:
 - For NMT, increasing k too much decreases BLEU score (Tu et al, Koehn et al). This is primarily because large- k beam search produces too-short translations (even with score normalization!)
 - In open-ended tasks like chit-chat dialogue, large k can make output more generic (see next slide)

Effect of beam size in chitchat dialogue

I mostly eat a fresh and raw diet, so I save on groceries



Human
chit-chat
partner

Beam size	Model response
1	<i>I love to eat healthy and eat healthy</i>
2	<i>That is a good thing to have</i>
3	<i>I am a nurse so I do not eat raw food</i>
4	<i>I am a nurse so I am a nurse</i>
5	<i>Do you have any hobbies?</i>
6	<i>What do you do for a living?</i>
7	<i>What do you do for a living?</i>
8	<i>What do you do for a living?</i>

Low beam size:
More on-topic but
nonsensical;
bad English

High beam size:
Converges to safe,
“correct” response,
but it’s generic and
less relevant

Sampling-based decoding

Both of these are **more efficient** than beam search
– no multiple hypotheses

- Pure sampling
 - On each step t , **randomly sample** from the probability distribution P_t to obtain your next word.
 - Like greedy decoding, but sample instead of argmax.
- Top- n sampling*
 - On each step t , randomly sample from P_t , **restricted to just the top- n most probable words**
 - Like pure sampling, but truncate the probability distribution
 - $n=1$ is greedy search, $n=V$ is pure sampling
 - **Increase n** to get more **diverse/risky** output
 - **Decrease n** to get more **generic/safe** output

*Usually called top- k sampling, but here we're avoiding confusion with beam size k



WebText



Beam Search, $b=16$

An unprecedented number of mostly young whales have become stranded on the West Australian coast since 2008.

The number of stranded whales has increased by more than 50 per cent in the past year, with the number of stranded whales on the West Australian coast increasing by more than 50 per cent in the past year. The number of whales stranded on the West Australian coast has increased by more than 50 per cent in the past year, with the number of stranded whales on the West Australian coast increasing by more than 50 per cent in the past year.



WebText



Beam Search, $b=16$



Pure Sampling

An unprecedented number of mostly young whales have become stranded on the West Australian coast since 2008.

The number of stranded whales has increased by more than 50 per cent in the past year, with the number of stranded whales on the West Australian coast increasing by more than 50 per cent in the past year. The number of whales stranded on the West Australian coast has increased by more than 50 per cent in the past year, with the number of stranded whales on the West Australian coast increasing by more than 50 per cent in the past year.

The Australian Food Safety Authority has warned Australia's beaches may be revitalised this year because healthy seabirds and seals have been on the move. More than 50,000 seabirds, sea mammals and seahorses have been swept into the sea by the Holden CS118 and Adelaide Airport CS300 from 2013. A major white-bat and umidauda migration across Australia is under way in Australia for the first time, with numbers reaching an estimated 50,000.



WebText

An unprecedented number of mostly young whales have become stranded on the West Australian coast since 2008.



Beam Search, $b=16$

The number of stranded whales has increased by more than 50 per cent in the past year, with the number of stranded whales on the West Australian coast increasing by more than 50 per cent in the past year. The number of whales stranded on the West Australian coast has increased by more than 50 per cent in the past year, with the number of stranded whales on the West Australian coast increasing by more than 50 per cent in the past year.



Pure Sampling

The Australian Food Safety Authority has warned Australia's beaches may be revitalised this year because healthy seabirds and seals have been on the move. More than 50,000 seabirds, sea mammals and seahorses have been swept into the sea by the Holden CS118 and Adelaide Airport CS300 from 2013. A major white-bat and umidauda migration across Australia is under way in Australia for the first time, with numbers reaching an estimated 50,000.



Top-k, $k=640$

Pumping Station #3 shut down due to construction damage Find more at:

www.abc.net.au/environment/species-worry/in-the-top-10-killer-whale-catastrophes-in-history.html

"In the top 10 killer whale catastrophes in history:

1) 1986: Up to 12 orcas struck by lightning; many drowned and many more badly injured.



Top-k, $k=40, t=0.7$

The whale's fate was confirmed late last week when the animal was found by fishermen off the coast of Bundaberg. Experts believe the whale was struck by a fishing vessel off the coast of Bundaberg, and died after being sucked into the ocean. The whale's fate was confirmed late last week when the animal was found by fishermen off the coast of Bundaberg.



WebText

An unprecedented number of mostly young whales have become stranded on the West Australian coast since 2008.

The number of stranded whales has increased by more than 50 per cent in the past year, with the number of stranded whales on the West Australian coast increasing by more than 50 per cent in the past year. The number of whales stranded on the West Australian coast has increased by more than 50 per cent in the past year, with the number of stranded whales on the West Australian coast increasing by more than 50 per cent in the past year.



Beam Search, $b=16$

The Australian Food Safety Authority has warned Australia's beaches may be revitalised this year because healthy seabirds and seals have been on the move. More than 50,000 seabirds, sea mammals and seahorses have been swept into the sea by the Holden CS118 and Adelaide Airport CS300 from 2013. A major white-bat and umidauda migration across Australia is under way in Australia for the first time, with numbers reaching an estimated 50,000.



Pure Sampling

Pumping Station #3 shut down due to construction damage Find more at:

www.abc.net.au/environment/species-worry/in-the-top-10-killer-whale-catastrophes-in-history.html

"In the top 10 killer whale catastrophes in history:

1) 1986: Up to 12 orcas struck by lightning; many drowned and many more badly injured.



Top-k, $k=640$

The whale's fate was confirmed late last week when the animal was found by fishermen off the coast of Bundaberg. Experts believe the whale was struck by a fishing vessel off the coast of Bundaberg, and died after being sucked into the ocean. The whale's fate was confirmed late last week when the animal was found by fishermen off the coast of Bundaberg.



Top-k, $k=40, t=0.7$

There has been an unprecedented number of calves caught in the nets of whaling stations that operate in WA. Pilot whales continue to migrate to feeding grounds to feed their calves. They are now vulnerable due to the decline of wild populations; they are restricted to one breeding site each year. Image copyright Yoon Bo Kim But, with sharp decline in wild populations the size of the Petrels are shrinking and dwindling population means there will only be room for a few new fowl.

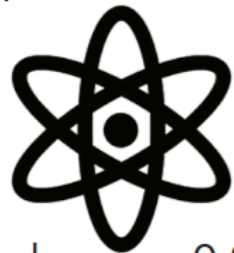

Nucleus, $p=0.95$

Decoding algorithms: in summary

- Greedy decoding is a simple method; gives low quality output
- Beam search (especially with high beam size) searches for high-probability output
 - Delivers better quality than greedy, but if beam size is too high, can return high-probability but unsuitable output (e.g. generic, short)
- Sampling methods are a way to get more diversity and randomness
 - Good for open-ended / creative generation (poetry, stories)
 - Top-n sampling allows you to control diversity

RankGen — Improving Text Generation with Large Ranking Models *(EMNLP 2022)*



Kalpesh Krishna



Yapei Chang



John Wieting



Mohit Iyyer

UMassAmherst

Manning College of Information
& Computer Sciences



The famous 🦄 discovered by GPT2-XL

Input: In a shocking finding, scientist discovered a herd of unicorns living in a remote, previously unexplored valley, in the Andes Mountains.

Generation (10x top-k sampling tries): The scientist named the population, after their distinctive horn, Ovid's Unicorn. These four-horned, silver-white unicorns were previously unknown to science. Now, after almost two centuries, the mystery of what sparked this odd phenomenon is finally solved. Dr. Jorge Pérez, an evolutionary biologist from the University of La Paz, and several companions, were exploring the Andes Mountains when they found a small valley, with no other animals or humans. Pérez noticed that the valley had what appeared to be a natural fountain, surrounded by two peaks of rock and silver snow. Pérez and the others then ventured further into the valley. "By the time we reached the top of one peak, the water looked blue, with some crystals on top," said Pérez. Pérez and his friends were astonished to see the unicorn herd. These creatures could be seen from the air without having to move too much to see them – they were so close they could touch their horns. While examining these bizarre creatures the scientists discovered that the creatures also spoke some fairly regular English.....

Greedy decoding / likelihood-based strategies

$$\operatorname{argmax} P_{lm}(x_i | x_1, \dots, x_{i-1})$$

BLOOM 170B

Hosted inference API ⓘ

Text Generation

Groups

Examples

In a shocking finding, scientist discovered a herd of unicorns living in a remote, previously unexplored valley, in the Andes Mountains. Even more surprising to the researchers was the fact that the unicorns spoke perfect English. The scientists were able to communicate with the unicorns, and were able to learn that the unicorns were not native to the area, but had been brought there by a group of explorers. The unicorns were brought to the valley by a group of explorers, who had been searching for a mythical land of gold. The unicorns were used as beasts of burden, to carry the explorers' supplies. The unicorns were not native to the area, but had been brought there by a group of explorers. The unicorns were brought to the valley by a group of explorers, who had been searching for a mythical land of gold.

sampling greedy

[BLOOM prompting tips](#)

Switch to "sampling" for more imaginative completions e.g. story/poetry (but which may be less accurate)

Compute

⌘+Enter

1.5

GPT3 170B

In a shocking finding, scientist discovered a herd of unicorns living in a remote, previously unexplored valley, in the Andes Mountains. Even more surprising to the researchers was the fact that the unicorns spoke perfect English.

"We were shocked to discover that the unicorns spoke perfect English," said Dr. David B. Givens, a scientist at the University of Kentucky. "We had no idea that unicorns could speak English."

The unicorns, who are all male, are a little over five feet tall and have a horn that is about three feet long. They are a little smaller than the average horse.

"They are very shy," said Dr. Givens. "They are very gentle and very kind. They are very intelligent. They are very curious. They are very playful. They are very social. They are very family oriented. They are very peaceful. They are very loving. They are very kind. They are very gentle. They are very loyal. They are very trustworthy. They are very honest. They are very respectful. They are very responsible. They are very hard working. They are very clean. They are very organized. They are very respectful. They are very responsible.

They are very hard working. They are very clean. They are very organized. They are very respectful. They are very responsible. They are very hard working. They are very clean. They are very

Greedy decoding / likelihood-based strategies

$$\operatorname{argmax} P_{lm}(x_i | x_1, \dots, x_{i-1})$$

BLOOM 170B

GPT3 170B

Hosted inference API ⓘ

Text Generation

Groups ▾

Examples ▾

In a shocking finding, scientist discovered a herd of unicorns living in a remote, previously unexplored valley, in the Andes Mountains. Even more surprising to the researchers was the fact that the unicorns spoke perfect English. The scientists were able to communicate with the unicorns, and were able to learn that the unicorns were not native to the area, but had been brought there by a group of explorers. The unicorns were brought to the valley by a group of explorers, who had been searching for a mythical land of gold. The unicorns were used as beasts of burden, to carry the explorers' supplies. The unicorns were not native to the area, but had been brought there by a group of explorers. The unicorns were brought to the valley by a group of explorers, who had been searching for a mythical land of gold.

In a shocking finding, scientist discovered a herd of unicorns living in a remote, previously unexplored valley, in the Andes Mountains. Even more surprising to the researchers was the fact that the unicorns spoke perfect English.

"We were shocked to discover that the unicorns spoke perfect English," said Dr. David B. Givens, a scientist at the University of Kentucky. "We had no idea that unicorns could speak English."

The unicorns, who are all male, are a little over five feet tall and have a horn that is about three feet long. They are a little smaller than the average horse.

"They are very shy," said Dr. Givens. "They are very gentle and very kind. They are very intelligent. They are very curious. They are very playful. They are very social. They are very family oriented. They are very peaceful. They are very loving. They are very kind. They are very gentle. They are very loyal. They are very trustworthy. They are very honest. They are very respectful. They are very responsible. They are very hard working. They are very clean. They are very organized. They are very respectful. They are very responsible. They are very hard working. They are very clean. They are very hard working. They are very clean. They are very organized. They are very respectful. They are very responsible. They are very hard working. They are very clean. They are very

sampling greedy

ⓘ BLOOM prompting tips

Switch to "sampling" for more imaginative completions e.g. story/poetry (but which may be less accurate)

Compute

⌘+Enter

1.5

Repetitive, dull

Ancestral Sampling / Full Sampling

$$\text{sample } P_{lm}(x_i \mid x_1, \dots, x_{i-1})$$

BLOOM 170B

GPT3 170B

⚡ Hosted inference API ⓘ

📄 Text Generation

Groups ▾

Examples ▾

In a shocking finding, scientist discovered a herd of unicorns living in a remote, previously unexplored valley, in the Andes Mountains. Even more surprising to the researchers was the fact that the unicorns spoke perfect English. **The story goes that the British inquisition had a group of escapees who were fleeing England and hid out in the mountains. Rather than be captured and returned, they gave up their British accents and now talk like this.**

The U.S. Government keeps most of this data secret, to the point that IRS records are exempt from Freedom of Information Act requests. Other unknown and non-random data is managed by government agencies and personal data such as your Social Security number (SSN) is collected by government and private entities with no means of opting out. Being in the U.S., your private data is used to calculate your taxes, determine eligibility for benefits such as health.

In a shocking finding, scientist discovered a herd of unicorns living in a remote, previously unexplored valley, in the Andes Mountains. Even more surprising to the researchers was the fact that the unicorns spoke perfect English.

The three field scientists were considering sending back a damage report when they were confronted by a curious scene. In a science journal article, first author Morgan N. Jones noted, "We are very excited to have found the unicorn herd, but we had not expected to find them in such great numbers or to have gathered together an immensely intelligent species that lived alongside us."

Since the encounter, the forest has remained an icon for the biodiversity within it and for the grave tragedies that have affected it.

But in the 1990s and early 2000s, the Colombian government became infiltrated by paramilitaries. The rise in paramilitary activity allowed armed groups to enter and exploit the resources of the forest. These activities took their toll on the ecosystem, the biodiversity and on the indigenous ethnic groups who live there.

Dianne Carroll, an ethnobotanist with the National Autonomous University of Mexico, has criticized the destruction of the forest. According to her article, it was engineered by logging and "often aimed at the fabulous and valuable trees for which commercial value determines international trade."

Corporate loggers have depleted rare species of hardwood timber trees and indiscriminately cleared previously healthy hillsides of trees yielding valuable mahogany, Afrom

Off-prompt



One great generation after 5-10 tries!

Mode



Model

davinci

Temperature 1

Maximum length 256

Stop sequences

Enter sequence and press Tab

Top P 0.87

Frequency penalty 0

Presence penalty 0

In a shocking finding, scientist discovered a herd of unicorns living in a remote, previously unexplored valley, in the Andes Mountains. Even more surprising to the researchers was the fact that the unicorns spoke perfect English. "We were startled to hear a herd of well-spoken English-speaking unicorns!" exclaimed one of the researchers. When approached by the researchers, the unicorns claimed to be the fabled creatures of myth and legend.

According to the mythological unicorns, they are the descendants of a lost colony of shipwrecked Portuguese explorers. In the 16th century, these explorers had discovered the previously unknown valley and claimed it as their own. The unicorns claim that they have lived in the valley ever since.

"We've had a rough time of it since the day we got here," said one of the unicorns. "Our settlement was cut off from the rest of the world by a wall of jagged, impassable mountains, and on the other side of those mountains lay the kingdom of the yeti. We lived here in harmony with the yeti for many years, but then one day a group of yeti attacked our settlement and killed most of our people. Some of us escaped into the mountains, where we survived by living off the land. We haven't been able to communicate with the outside world for decades. We are very happy to be found."

The unicorns of legend have been known for their powers of healing and their intelligence. The scientific community is divided as to whether these particular unicorns have retained their magical powers. Some scientists are skeptical. "I think these unicorns are just regular horses with exceptionally well-groomed hair," said one scientist.

The unicorns plan to remain in the valley, living a quiet existence away from the rest of the world. Scientists will continue to study them in the hopes of unlocking the mysteries of their unique appearance and behavior.

(For the complete story, purchase this week's edition of The Whetstone)

Generated text is very sensitive to the decoding algorithm

Mode

Model: davinci

Temperature: 1

Maximum length: 256

Stop sequences: Enter sequence and press Tab

Top P: 0.87

Frequency penalty: 0

Presence penalty: 0

```

f generate
<source>
( inputs: typing.Optional[torch.Tensor] = None, max_length: typing.Optional[int] = None, min_length:
typing.Optional[int] = None, do_sample: typing.Optional[bool] = None, early_stopping:
typing.Optional[bool] = None, num_beams: typing.Optional[int] = None, temperature:
typing.Optional[float] = None, top_k: typing.Optional[int] = None, top_p: typing.Optional[float] =
None, typical_p: typing.Optional[float] = None, repetition_penalty: typing.Optional[float] = None,
bad_words_ids: typing.Optional[typing.Iterable[int]] = None, force_words_ids:
typing.Union[typing.Iterable[int], typing.Iterable[typing.Iterable[int]], NoneType] = None,
bos_token_id: typing.Optional[int] = None, pad_token_id: typing.Optional[int] = None, eos_token_id:
typing.Optional[int] = None, length_penalty: typing.Optional[float] = None, no_repeat_ngram_size:
typing.Optional[int] = None, encoder_no_repeat_ngram_size: typing.Optional[int] = None,
num_return_sequences: typing.Optional[int] = None, max_time: typing.Optional[float] = None,
max_new_tokens: typing.Optional[int] = None, decoder_start_token_id: typing.Optional[int] = None,
use_cache: typing.Optional[bool] = None, num_beam_groups: typing.Optional[int] = None,
diversity_penalty: typing.Optional[float] = None, prefix_allowed_tokens_fn:
typing.Union[typing.Callable[[int, torch.Tensor], typing.List[int]], NoneType] = None,
logits_processor: typing.Optional[transformers.generation_logits_process.LogitsProcessorList] = [],
renormalize_logits: typing.Optional[bool] = None, stopping_criteria:
typing.Optional[transformers.generation_stopping_criteria.StoppingCriteriaList] = [], constraints:
typing.Optional[typing.List[transformers.generation_beam_constraints.Constraint]] = None,
output_attentions: typing.Optional[bool] = None, output_hidden_states: typing.Optional[bool] = None,
output_scores: typing.Optional[bool] = None, return_dict_in_generate: typing.Optional[bool] = None,
forced_bos_token_id: typing.Optional[int] = None, forced_eos_token_id: typing.Optional[int] = None,
remove_invalid_values: typing.Optional[bool] = None, synced_gpus: typing.Optional[bool] = False,
exponential_decay_length_penalty: typing.Union[typing.Tuple[typing.Union[int, float]], NoneType] =
None, **model_kwargs ) -> ModelOutput or torch.LongTensor
    
```

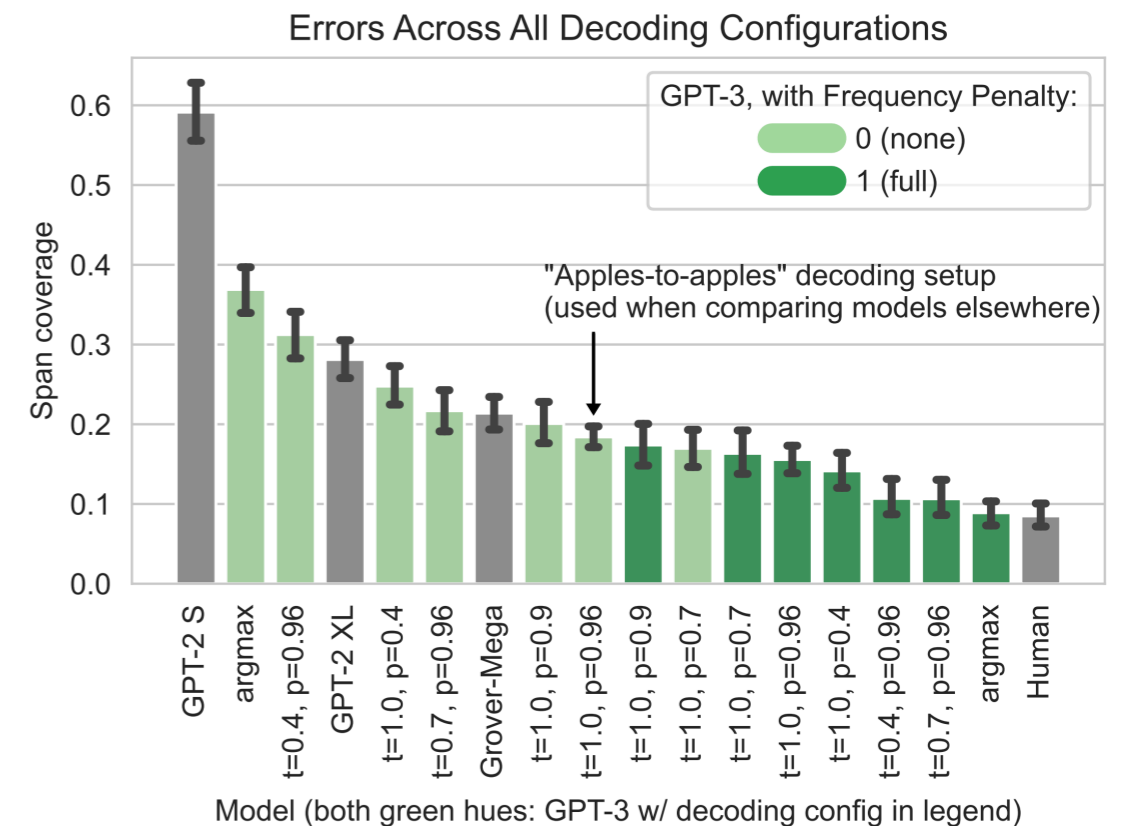

OpenAI API

HuggingFace generate API

Dou, Forbes, Koncel-Kedziorski, Smith, Choi 2022
 SCARECROW: A Framework for Scrutinizing Machine Text

Despite low PPL, why is decoding text challenging?

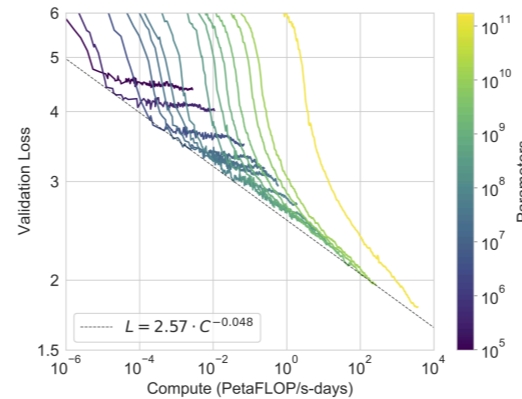

Language models need to be bigger / more data

Wrong training objective

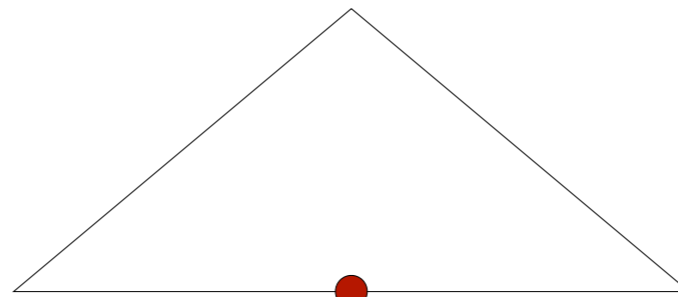
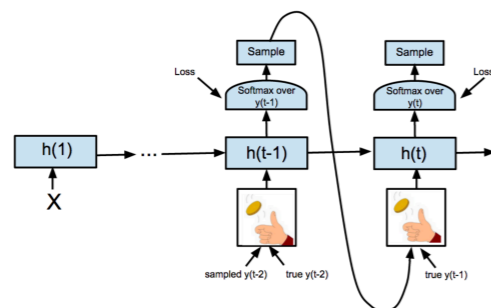

RankGen
(our work)

Wrong decoding / search strategy

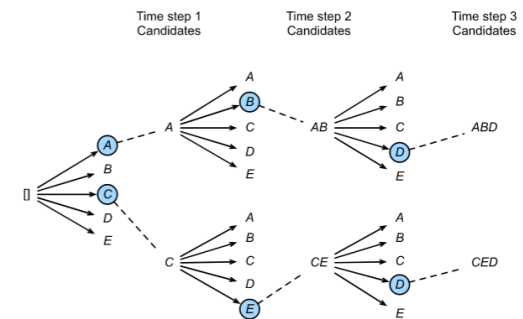

For a week or two after Wendy came it was doubtful whether they would be able to keep her, as she was another mouth to feed. Mr. Darling was frightfully proud of her, but he was very honourable, and he sat on the edge of Mrs. Darling's bed, holding her hand and calculating expenses, while she looked at him imploringly. She wanted to risk it, come what might, but that was not his way; his way was with a pencil and a piece of paper, and if she confused him with suggestions he had to begin at the beginning again. "Now don't interrupt," he would beg of her. "I have one pound seventeen here, and two and six at the office; I can cut off my coffee at the office, say ten shillings, making two nine and six, with your eighteen and three makes three nine seven, with five naught naught in my cheque-book makes eight nine seven—who is that moving?—eight nine seven, dot and carry seven—don't speak, my own—and the pound you lent to that man who came to the door—quiet, child—dot and carry child—there, you've done it!—did I say nine nine seven? yes, I said nine nine seven; the question is, can we try it for a year on nine nine seven?" "Of course we can, George," she cried. But she was prejudiced in Wendy's favour, and he was really the grander character of the two. "Remember mumps," he warned her almost threateningly, and off he went again. "Mumps one pound, that is what I have put down, but I daresay it will be more like thirty shillings—don't speak—measles one five, German measles half a guinea, makes two fifteen six—don't waggle your finger—whooping-cough, say fifteen shillings"—and so on it went, and it added up differently each time; but at last Wendy just got through, with mumps reduced to twelve six, and the two kinds of measles treated as one. There was the same excitement over John, and Michael had even a narrower squeak; but both were kept, and soon, you might have seen the three of them going in a row to Miss Fulsom's Kindergarten school, accompanied by their nurse. Mrs. Darling loved to have everything just so, and Mr. Darling had a passion for being exactly like his neighbours; so, of course, they had a nurse. As they were poor, owing to the amount of milk the children drank, this nurse was a prim Newfoundland dog, called Nana, who had belonged to no one in particular until the Darlings engaged her. She had always thought children important, however, and the Darlings had become acquainted with her in Kensington Gardens, where she spent most of her spare time peeping into perambulators, and was much hated by careless nursemaids, whom she followed to their homes and complained of to their mistresses. She proved to be quite a treasure of a nurse. How thorough she was at bath-time, and up at any moment of the night if one of her charges made the slightest cry. Of course her kennel was in the nursery. She had a genius for knowing when a cough is a thing to have no patience with and when it needs stocking around your throat. She believed to her last day in old-fashioned remedies like rhubarb leaf, and made sounds of contempt over all this new-fangled talk about germs, and so on. It was a lesson in propriety to see her escorting the children to school, walking sedately by their side when they were well behaved, and butting them back into line if they strayed. On John's footer days she never once forgot his sweater, and she usually carried an umbrella in her mouth in case of rain. There is a room in the basement of Miss Fulsom's school where the nurses wait. They sat on forms, while Nana lay on the floor, but that was the only difference. They affected to ignore her as of an inferior social status to themselves, and she despised their light talk. She resented visits to the nursery from Mrs. Darling's friends, but if they did come she first whipped off Michael's pinafore and put him into the one with blue braiding, and smoothed out Wendy and made a dash at John's hair. No nursery could possibly have been conducted more correctly, and Mr. Darling knew it, yet he sometimes wondered uneasily whether the neighbours talked. He had his position in the city to consider. Nana also troubled him in another way. He had sometimes a feeling that she did not admire him. "I know she admires you tremendously, George," Mrs. Darling would assure him, and then she would sign to the children to be specially nice to father. Lovely dances followed, in which the only other servant, Liza, was sometimes allowed to join. Such a midget she looked in her long skirt and maid's cap, though she had sworn, when engaged, that she would never see ten again. The gaiety of those romps! And gayest of all was Mrs. Darling, who would pirouette so wildly that all you could see of her was the kiss, and then if you had dashed at her you might have got it. There never was a simpler happier family until the coming of Peter Pan. Mrs. Darling first heard of Peter when she was tidying up her children's minds. It is the nightly custom of every good mother after her children are asleep to rummage in their minds and put things straight for next morning, repacking into their proper places the many articles that have wandered during the day. If you could keep awake (but of course you can't) you would see your own mother doing this, and you would find it very interesting to watch her. It is quite like tidying up drawers. You would see her on her knees, I expect, lingering humorously over some of your contents, wondering where on earth you had picked this thing up, making discoveries sweet and not so sweet, pressing this to her cheek as if it were as nice as a kitten, and hurriedly stowing that out of sight. When you wake in the morning, the naughtiness and evil passions with which you went to bed have been folded up small and placed at the bottom of your mind and on the top, beautifully aired, are spread out your prettier thoughts, ready for you to put on. I don't know whether you have ever seen a map of a person's mind. Doctors sometimes draw maps of other parts of you, and your own map can become intensely interesting, but catch them trying to draw a map of a child's mind, which is not only confused, but keeps going round all the time. There are zigzag lines on it, just like your temperature on a card, and these are probably roads in the island, for the Neverland is always more or less an island, with astonishing splashes of colour here and there, and coral reefs and rakish-looking craft in the offing, and savages and lonely lairs, and gnomes who are mostly tailors, and caves through which a river runs, and princes with six elder brothers, and a hut fast going to decay, and one very small old lady with a hooked nose. It would be an easy map if that were all, but there is also first day at school, religion, fathers, the round pond, needle-work, murders, hangings, verbs that take the dative, chocolate pudding day, getting into braces, say ninety-nine, three-pence for pulling out your tooth yourself, and so on, and either these are part of the island or they are another map showing through, and it is all rather confusing, especially as nothing will stand still.

For a week or two after Wendy came it was doubtful whether they would be able to keep her, as she was another mouth to feed. Mr. Darling was frightfully proud of her, but he was very honourable, and he sat on the edge of Mrs. Darling's bed, holding her hand and calculating expenses, while she looked at him imploringly. She wanted to risk it, come what might, but that was not his way; his way was with a pencil and a piece of paper, and if she confused him with suggestions he had to begin at the beginning again. "Now don't interrupt," he would beg of her. "I have one pound seventeen here, and two and six at the office; I can cut off my coffee at the office, say ten shillings, making two nine and six, with your eighteen and three makes three nine seven, with five naught naught in my cheque-book makes eight nine seven—who is that moving?—eight nine seven, dot and carry seven—don't speak, my own—and the pound you lent to that man who came to the door—quiet, child—dot and carry child—there, you've done it!—did I say nine nine seven? yes, I said nine nine seven; the question is, can we try it for a year on nine nine seven?" "Of course we can, George," she cried. But she was prejudiced in Wendy's favour, and he was really the grander character of the two. "Remember mumps," he warned her almost threateningly, and off he went again. "Mumps one pound, that is what I have put down, but I daresay it will be more like thirty shillings—don't speak—measles one five, German measles half a guinea, makes two fifteen six—don't waggle your finger—whooping-cough, say fifteen shillings"—and so on it went, and it added up differently each time; but at last Wendy just got through, with mumps reduced to twelve six, and the two kinds of measles treated as one. There was the same excitement over John, and Michael had even a narrower squeak; but both were kept, and soon, you might have seen the three of them going in a row to Miss Fulsom's Kindergarten school, accompanied by their nurse. Mrs. Darling loved to have everything just so, and Mr. Darling had a passion for being exactly like his neighbours; so, of course, they had a nurse. As they were poor, owing to the amount of milk the children drank, this nurse was a prim Newfoundland dog, called Nana, who had belonged to no one in particular until the Darlings engaged her. She had always thought children important, however, and the Darlings had become acquainted with her in Kensington Gardens, where she spent most of her spare time peeping into perambulators, and was much hated by careless nursemaids, whom she followed to their homes and complained of to their mistresses. She proved to be quite a treasure of a nurse. How thorough she was at bath-time, and up at any moment of the night if one of her charges made the slightest cry. Of course her kennel was in the nursery. She had a genius for knowing when a cough is a thing to have no patience with and when it needs stocking around your throat. She believed to her last day in old-fashioned remedies like rhubarb leaf, and made sounds of contempt over all this new-fangled talk about germs, and so on. It was a lesson in propriety to see her escorting the children to school, walking sedately by their side when they were well behaved, and butting them back into line if they strayed. On John's footer days she never once forgot his sweater, and she usually carried an umbrella in her mouth in case of rain. There is a room in the basement of Miss Fulsom's school where the nurses wait. They sat on forms, while Nana lay on the floor, but that was the only difference. They affected to ignore her as of an inferior social status to themselves, and she despised their light talk. She resented visits to the nursery from Mrs. Darling's friends, but if they did come she first whipped off Michael's pinafore and put him into the one with blue braiding, and smoothed out Wendy and made a dash at John's hair. No nursery could possibly have been conducted more correctly, and Mr. Darling knew it, yet he sometimes wondered uneasily whether the neighbours talked. He had his position in the city to consider. Nana also troubled him in another way. He had sometimes a feeling that she did not admire him. "I know she admires you tremendously, George," Mrs. Darling would assure him, and then she would sign to the children to be specially nice to father. Lovely dances followed, in which the only other servant, Liza, was sometimes allowed to join. Such a midget she looked in her long skirt and maid's cap, though she had sworn, when engaged, that she would never see ten again. The gaiety of those romps! And gayest of all was Mrs. Darling, who would pirouette so wildly that all you could see of her was the kiss, and then if you had dashed at her you might have got it. There never was a simpler happier family until the coming of Peter Pan. Mrs. Darling first heard of Peter when she was tidying up her children's minds. It is the nightly custom of every good mother after her children are asleep to rummage in their minds and put things straight for next morning, repacking into their proper places the many articles that have wandered during the day. If you could keep awake (but of course you can't) you would see your own mother doing this, and you would find it very interesting to watch her. It is quite like tidying up drawers. You would see her on her knees, I expect, lingering humorously over some of your contents, wondering where on earth you had picked this thing up, making discoveries sweet and not so sweet, pressing this to her cheek as if it were as nice as a kitten, and hurriedly stowing that out of sight. When you wake in the morning, the naughtiness and evil passions with which you went to bed have been folded up small and placed at the bottom of your mind and on the top, beautifully aired, are spread out your prettier thoughts, ready for you to put on. I don't know whether you have ever seen a map of a person's mind. Doctors sometimes draw maps of other parts of you, and your own map can become intensely interesting, but catch them trying to draw a map of a child's mind, which is not only confused, but keeps going round all the time. There are zigzag lines on it, just like your temperature on a card, and these are probably roads in the island, for the Neverland is always more or less an island, with astonishing splashes of colour here and there, and coral reefs and rakish-looking craft in the offing, and savages and lonely lairs, and gnomes who are mostly tailors, and caves through which a river runs, and princes with six elder brothers, and a hut fast going to decay, and one very small old lady with a hooked nose. It would be an easy map if that were all, but there is also first day at school, religion, fathers, the round pond, needle-work, murders, hangings, verbs that take the dative, chocolate pudding day, getting into braces, say ninety-nine, three-pence for pulling out your tooth yourself, and so on, and either these are part of the island or they are another map showing through, and it is all rather confusing, especially as nothing will stand still.

prefix

For a week or two after Wendy came it was doubtful whether they would be able to keep her, as she was another mouth to feed. Mr. Darling was frightfully proud of her, but he was very honourable, and he sat on the edge of Mrs. Darling's bed, holding her hand and calculating expenses, while she looked at him imploringly. She wanted to risk it, come what might, but that was not his way; his way was with a pencil and a piece of paper, and if she confused him with suggestions he had to begin at the beginning again. "Now don't interrupt," he would beg of her. "I have one pound seventeen here, and two and six at the office; I can cut off my coffee at the office, say ten shillings, making two nine and six, with your eighteen and three makes three nine seven, with five naught naught in my cheque-book makes eight nine seven—who is that moving?—eight nine seven, dot and carry seven—don't speak, my own—and the pound you lent to that man who came to the door—quiet, child—dot and carry child—there, you've done it!—did I say nine nine seven? yes, I said nine nine seven; the question is, can we try it for a year on nine nine seven?" "Of course we can, George," she cried. But she was prejudiced in Wendy's favour, and he was really the grander character of the two. "Remember mumps," he warned her almost threateningly, and off he went again. "Mumps one pound, that is what I have put down, but I daresay it will be more like thirty shillings—don't speak—measles one five, German measles half a guinea, makes two fifteen six—don't waggle your finger—whooping-cough, say fifteen shillings"—and so on it went, and it added up differently each time; but at last Wendy just got through, with mumps reduced to twelve six, and the two kinds of measles treated as one. There was the same excitement over John, and Michael had even a narrower squeak; but both were kept, and soon, you might have seen the three of them going in a row to Miss Fulsom's Kindergarten school, accompanied by their nurse. Mrs. Darling loved to have everything just so, and Mr. Darling had a passion for being exactly like his neighbours; so, of course, they had a nurse. As they were poor, owing to the amount of milk the children drank, this nurse was a prim Newfoundland dog, called Nana, who had belonged to no one in particular until the Darlings engaged her. She had always thought children important, however, and the Darlings had become acquainted with her in Kensington Gardens, where she spent most of her spare time peeping into perambulators, and was much hated by careless nursemaids, whom she followed to their homes and complained of to their mistresses. She proved to be quite a treasure of a nurse. How thorough she was at bath-time, and up at any moment of the night if one of her charges made the slightest cry. Of course her kennel was in the nursery. She had a genius for knowing when a cough is a thing to have no patience with and when it needs stocking around your throat. She believed to her last day in old-fashioned remedies like rhubarb leaf, and made sounds of contempt over all this new-fangled talk about germs, and so on. It was a lesson in propriety to see her escorting the children to school, walking sedately by their side when they were well behaved, and butting them back into line if they strayed. On John's footer days she never once forgot his sweater, and she usually carried an umbrella in her mouth in case of rain. There is a room in the basement of Miss Fulsom's school where the nurses wait. They sat on forms, while Nana lay on the floor, but that was the only difference. They affected to ignore her as of an inferior social status to themselves, and she despised their light talk. She resented visits to the nursery from Mrs. Darling's friends, but if they did come she first whipped off Michael's pinafore and put him into the one with blue braiding, and smoothed out Wendy and made a dash at John's hair. No nursery could possibly have been conducted more correctly, and Mr. Darling knew it, yet he sometimes wondered uneasily whether the neighbours talked. He had his position in the city to consider. Nana also troubled him in another way. He had sometimes a feeling that she did not admire him. "I know she admires you tremendously, George," Mrs. Darling would assure him, and then she would sign to the children to be specially nice to father. Lovely dances followed, in which the only other servant, Liza, was sometimes allowed to join. Such a midget she looked in her long skirt and maid's cap, though she had sworn, when engaged, that she would never see ten again. The gaiety of those romps! And gayest of all was Mrs. Darling, who would pirouette so wildly that all you could see of her was the kiss, and then if you had dashed at her you might have got it. There never was a simpler happier family until the coming of Peter Pan. Mrs. Darling first heard of Peter when she was tidying up her children's minds. It is the nightly custom of every good mother after her children are asleep to rummage in their minds and put things straight for next morning, repacking into their proper places the many articles that have wandered during the day. If you could keep awake (but of course you can't) you would see your own mother doing this, and you would find it very interesting to watch her. It is quite like tidying up drawers. You would see her on her knees, I expect, lingering humorously over some of your contents, wondering where on earth you had picked this thing up, making discoveries sweet and not so sweet, pressing this to her cheek as if it were as nice as a kitten, and hurriedly stowing that out of sight. When you wake in the morning, the naughtiness and evil passions with which you went to bed have been folded up small and placed at the bottom of your mind and on the top, beautifully aired, are spread out your prettier thoughts, ready for you to put on. I don't know whether you have ever seen a map of a person's mind. Doctors sometimes draw maps of other parts of you, and your own map can become intensely interesting, but catch them trying to draw a map of a child's mind, which is not only confused, but keeps going round all the time. There are zigzag lines on it, just like your temperature on a card, and these are probably roads in the island, for the Neverland is always more or less an island, with astonishing splashes of colour here and there, and coral reefs and rakish-looking craft in the offing, and savages and lonely lairs, and gnomes who are mostly tailors, and caves through which a river runs, and princes with six elder brothers, and a hut fast going to decay, and one very small old lady with a hooked nose. It would be an easy map if that were all, but there is also first day at school, religion, fathers, the round pond, needle-work, murders, hangings, verbs that take the dative, chocolate pudding day, getting into braces, say ninety-nine, three-pence for pulling out your tooth yourself, and so on, and either these are part of the island or they are another map showing through, and it is all rather confusing, especially as nothing will stand still.

prefix

gold suffix

For a week or two after Wendy came it was doubtful whether they would be able to keep her, as she was another mouth to feed. Mr. Darling was frightfully proud of her, but he was very honourable, and he sat on the edge of Mrs. Darling's bed, holding her hand and calculating expenses, while she looked at him imploringly. She wanted to risk it, come what might, but that was not his way; his way was with a pencil and a piece of paper, and if she confused him with suggestions he had to begin at the beginning again. "Now don't interrupt," he would beg of her. "I have one pound seventeen here, and two and six at the office; I can cut off my coffee at the office, say ten shillings, making two nine and six, with your eighteen and three makes three nine seven, with five naught naught in my cheque-book makes eight nine seven—who is that moving?—eight nine seven, dot and carry seven—don't speak, my own—and the pound you lent to that man who came to the door—quiet, child—dot and carry child—there, you've done it!—did I say nine nine seven? yes, I said nine nine seven; the question is, can we try it for a year on nine nine seven?" "Of course we can, George," she cried. But she was prejudiced in Wendy's favour, and he was really the grander character of the two. "Remember mumps," he warned her almost threateningly, and off he went again. "Mumps one pound, that is what I have put down, but I daresay it will be more like thirty shillings—don't speak—measles one five, German measles half a guinea, makes two fifteen six—don't waggle your finger—whooping-cough, say fifteen shillings"—and so on it went, and it added up differently each time; but at last Wendy just got through, with mumps reduced to twelve six, and the two kinds of measles treated as one. There was the same excitement over John, and Michael had even a narrower squeak; but both were kept, and soon, you might have seen the three of them going in a row to Miss Fulsom's Kindergarten school, accompanied by their nurse. Mrs. Darling loved to have everything just so, and Mr. Darling had a passion for being exactly like his neighbours; so, of course, they had a nurse. As they were poor, owing to the amount of milk the children drank, this nurse was a prim Newfoundland dog, called Nana, who had belonged to no one in particular until the Darlings engaged her. She had always thought children important, however, and the Darlings had become acquainted with her in Kensington Gardens, where she spent most of her spare time peeping into perambulators, and was much hated by careless nursemaids, whom she followed to their homes and complained of to their mistresses. She proved to be quite a treasure of a nurse. How thorough she was at bath-time, and up at any moment of the night if one of her charges made the slightest cry. Of course her kennel was in the nursery. She had a genius for knowing when a cough is a thing to have no patience with and when it needs stocking around your throat. She believed to her last day in old-fashioned remedies like rhubarb leaf, and made sounds of contempt over all this new-fangled talk about germs, and so on. It was a lesson in propriety to see her escorting the children to school, walking sedately by their side when they were well behaved, and butting them back into line if they strayed. On John's footer days she never once forgot his sweater, and she usually carried an umbrella in her mouth in case of rain. There is a room in the basement of Miss Fulsom's school where the nurses wait. They sat on forms, while Nana lay on the floor, but that was the only difference. They affected to ignore her as of an inferior social status to themselves, and she despised their light talk. She resented visits to the nursery from Mrs. Darling's friends, but if they did come she first whipped off Michael's pinafore and put him into the one with blue braiding, and smoothed out Wendy and made a dash at John's hair. No nursery could possibly have been conducted more correctly, and Mr. Darling knew it, yet he sometimes wondered uneasily whether the neighbours talked. He had his position in the city to consider. Nana also troubled him in another way. He had sometimes a feeling that she did not admire him. "I know she admires you tremendously, George," Mrs. Darling would assure him, and then she would sign to the children to be specially nice to father. Lovely dances followed, in which the only other servant, Liza, was sometimes allowed to join. Such a midget she looked in her long skirt and maid's cap, though she had sworn, when engaged, that she would never see ten again. The gaiety of those romps! And gayest of all was Mrs. Darling, who would pirouette so wildly that all you could see of her was the kiss, and then if you had dashed at her you might have got it. There never was a simpler happier family until the coming of Peter Pan. Mrs. Darling first heard of Peter when she was tidying up her children's minds. It is the nightly custom of every good mother after her children are asleep to rummage in their minds and put things straight for next morning, repacking into their proper places the many articles that have wandered during the day. If you could keep awake (but of course you can't) you would see your own mother doing this, and you would find it very interesting to watch her. It is quite like tidying up drawers. You would see her on her knees, I expect, lingering humorously over some of your contents, wondering where on earth you had picked this thing up, making discoveries sweet and not so sweet, pressing this to her cheek as if it were as nice as a kitten, and hurriedly stowing that out of sight. When you wake in the morning, the naughtiness and evil passions with which you went to bed have been folded up small and placed at the bottom of your mind and on the top, beautifully aired, are spread out your prettier thoughts, ready for you to put on. I don't know whether you have ever seen a map of a person's mind. Doctors sometimes draw maps of other parts of you, and your own map can become intensely interesting, but catch them trying to draw a map of a child's mind, which is not only confused, but keeps going round all the time. There are zigzag lines on it, just like your temperature on a card, and these are probably roads in the island, for the Neverland is always more or less an island, with astonishing splashes of colour here and there, and coral reefs and rakish-looking craft in the offing, and savages and lonely lairs, and gnomes who are mostly tailors, and caves through which a river runs, and princes with six elder brothers, and a hut fast going to decay, and one very small old lady with a hooked nose. It would be an easy map if that were all, but there is also first day at school, religion, fathers, the round pond, needle-work, murders, hangings, verbs that take the dative, chocolate pudding day, getting into braces, say ninety-nine, three-pence for pulling out your tooth yourself, and so on, and either these are part of the island or they are another map showing through, and it is all rather confusing, especially as nothing will stand still.

random suffix

prefix

gold suffix

For a week or two after Wendy came it was doubtful whether they would be able to keep her, as she was another mouth to feed. Mr. Darling was frightfully proud of her, but he was very honourable, and he sat on the edge of Mrs. Darling's bed, holding her hand and calculating expenses, while she looked at him imploringly. She wanted to risk it, come what might, but that was not his way; his way was with a pencil and a piece of paper, and if she confused him with suggestions he had to begin at the beginning again. "Now don't interrupt," he would beg of her. "I have one pound seventeen here, and two and six at the office; I can cut off my coffee at the office, say ten shillings, making two nine and six, with your eighteen and three makes three nine seven, with five naught naught in my cheque-book makes eight nine seven—who is that moving?—eight nine seven, dot and carry seven—don't speak, my own—and the pound you lent to that man who came to the door—quiet, child—dot and carry child—there, you've done it!—did I say nine nine seven? yes, I said nine nine seven; the question is, can we try it for a year on nine nine seven?" "Of course we can, George," she cried. But she was prejudiced in Wendy's favour, and he was really the grander character of the two. "Remember mumps," he warned her almost threateningly, and off he went again. "Mumps one pound, that is what I have put down, but I daresay it will be more like thirty shillings—don't speak—measles one five, German measles half a guinea, makes two fifteen six—don't waggle your finger—whooping-cough, say fifteen shillings"—and so on it went, and it added up differently each time; but at last Wendy just got through, with mumps reduced to twelve six, and the two kinds of measles treated as one. There was the same excitement over John, and Michael had even a narrower squeak; but both were kept, and soon, you might have seen the three of them going in a row to Miss Fulsom's Kindergarten school, accompanied by their nurse. Mrs. Darling loved to have everything just so, and Mr. Darling had a passion for being exactly like his neighbours; so, of course, they had a nurse. As they were poor, owing to the amount of milk the children drank, this nurse was a prim Newfoundland dog, called Nana, who had belonged to no one in particular until the Darlings engaged her. She had always thought children important, however, and the Darlings had become acquainted with her in Kensington Gardens, where she spent most of her spare time peeping into perambulators, and was much hated by careless nursemaids, whom she followed to their homes and complained of to their mistresses. She proved to be quite a treasure of a nurse. How thorough she was at bath-time, and up at any moment of the night if one of her charges made the slightest cry. Of course her kennel was in the nursery. She had a genius for knowing when a cough is a thing to have no patience with and when it needs stocking around your throat. She believed to her last day in old-fashioned remedies like rhubarb leaf, and made sounds of contempt over all this new-fangled talk about germs, and so on. It was a lesson in propriety to see her escorting the children to school, walking sedately by their side when they were well behaved, and butting them back into line if they strayed. On John's footer days she never once forgot his sweater, and she usually carried an umbrella in her mouth in case of rain. There is a room in the basement of Miss Fulsom's school where the nurses wait. They sat on forms, while Nana lay on the floor, but that was the only difference. They affected to ignore her as of an inferior social status to themselves, and she despised their light talk. She resented visits to the nursery from Mrs. Darling's friends, but if they did come she first whipped off Michael's pinafore and put him into the one with blue braiding, and smoothed out Wendy and made a dash at John's hair. No nursery could possibly have been conducted more correctly, and Mr. Darling knew it, yet he sometimes wondered uneasily whether the neighbours talked. He had his position in the city to consider. Nana also troubled him in another way. He had sometimes a feeling that she did not admire him. "I know she admires you tremendously, George," Mrs. Darling would assure him, and then she would sign to the children to be specially nice to father. Lovely dances followed, in which the only other servant, Liza, was sometimes allowed to join. Such a midget she looked in her long skirt and maid's cap, though she had sworn, when engaged, that she would never see ten again. The gaiety of those romps! And gayest of all was Mrs. Darling, who would pirouette so wildly that all you could see of her was the kiss, and then if you had dashed at her you might have got it. There never was a simpler happier family until the coming of Peter Pan. Mrs. Darling first heard of Peter when she was tidying up her children's minds. It is the nightly custom of every good mother after her children are asleep to rummage in their minds and put things straight for next morning, repacking into their proper places the many articles that have wandered during the day. If you could keep awake (but of course you can't) you would see your own mother doing this, and you would find it very interesting to watch her. It is quite like tidying up drawers. You would see her on her knees, I expect, lingering humorously over some of your contents, wondering where on earth you had picked this thing up, making discoveries sweet and not so sweet, pressing this to her cheek as if it were as nice as a kitten, and hurriedly stowing that out of sight. When you wake in the morning, the naughtiness and evil passions with which you went to bed have been folded up small and placed at the bottom of your mind and on the top, beautifully aired, are spread out your prettier thoughts, ready for you to put on. I don't know whether you have ever seen a map of a person's mind. Doctors sometimes draw maps of other parts of you, and your own map can become intensely interesting, but catch them trying to draw a map of a child's mind, which is not only confused, but keeps going round all the time. There are zigzag lines on it, just like your temperature on a card, and these are probably roads in the island, for the Neverland is always more or less an island, with astonishing splashes of colour here and there, and coral reefs and rakish-looking craft in the offing, and savages and lonely lairs, and gnomes who are mostly tailors, and caves through which a river runs, and princes with six elder brothers, and a hut fast going to decay, and one very small old lady with a hooked nose. It would be an easy map if that were all, but there is also first day at school, religion, fathers, the round pond, needle-work, murders, hangings, verbs that take the dative, chocolate pudding day, getting into braces, say ninety-nine, three-pence for pulling out your tooth yourself, and so on, and either these are part of the island or they are another map showing through, and it is all rather confusing, especially as nothing will stand still.

Suffix Identification

Given a **prefix**, does the language model prefer the **gold suffix** over a **random suffix** from same book?

$$P_{LM}(\text{gold suffix} \mid \text{prefix})$$

$$> P_{LM}(\text{random suffix} \mid \text{prefix}) ?$$

Language Model	PG19 (random)	Wikipedia (random)
Random	50.0	50.0
GPT2-XL	72.3	63.2
GPT3-175B	78.2	67.7
Humans	94.5	91.0

Why do LMs prefer these negatives?

For a week or two after Wendy came it was doubtful whether they would be able to keep her, as she was another mouth to feed. Mr. Darling was frightfully proud of her, but he was very honourable, and he sat on the edge of Mrs. Darling's bed, holding her hand and calculating expenses, while she looked at him imploringly. She wanted to risk it, come what might, but that was not his way; his way was with a pencil and a piece of paper, and if she confused him with suggestions he had to begin at the beginning again. "Now don't interrupt," he would beg of her. "I have one pound seventeen here, and two and six at the office; I can cut off my coffee at the office, say ten shillings, making two nine and six, with your eighteen and three makes three nine seven, with five naught naught in my cheque-book makes eight nine seven—who is that moving?—eight nine seven, dot and carry seven—don't speak, my own—and the pound you lent to that man who came to the door—quiet, child—dot and carry child—there, you've done it!—did I say nine nine seven? yes, I said nine nine seven; the question is, can we try it for a year on nine nine seven?" "Of course we can, George," she cried. But she was prejudiced in Wendy's favour, and he was really the grander character of the two. "Remember mumps," he warned her almost threateningly, and off he went again. "Mumps one pound, that is what I have put down, but I daresay it will be more like thirty shillings—don't speak—measles one five, German measles half a guinea, makes two fifteen six—don't waggle your finger—whooping-cough, say fifteen shillings"—and so on it went, and it added up differently each time; but at last Wendy just got through, with mumps reduced to twelve six, and the two kinds of measles treated as one. There was the same excitement over John, and Michael had even a narrower squeak; but both were kept, and soon, you might have seen the three of them going in a row to Miss Fulsom's Kindergarten school, accompanied by their nurse. Mrs. Darling loved to have everything just so, and Mr. Darling had a passion for being exactly like his neighbours; so, of course, they had a nurse. As they were poor, owing to the amount of milk the children drank, this nurse was a prim Newfoundland dog, called Nana, who had belonged to no one in particular until the Darlings engaged her. She had always thought children important, however, and the Darlings had become acquainted with her in Kensington Gardens, where she spent most of her spare time peeping into perambulators, and was much hated by careless nursemaids, whom she followed to their homes and complained of to their mistresses. She proved to be quite a treasure of a nurse. How thorough she was at bath-time, and up at any moment of the night if one of her charges made the slightest cry. Of course her kennel was in the nursery. She had a genius for knowing when a cough is a thing to have no patience with and when it needs stocking around your throat. She believed to her last day in old-fashioned remedies like rhubarb leaf, and made sounds of contempt over all this new-fangled talk about germs, and so on. It was a lesson in propriety to see her escorting the children to school, walking sedately by their side when they were well behaved, and butting them back into line if they strayed. On John's footer days she never once forgot his sweater, and she usually carried an umbrella in her mouth in case of rain. There is a room in the basement of Miss Fulsom's school where the nurses wait. They sat on forms, while Nana lay on the floor, but that was the only difference. They affected to ignore her as of an inferior social status to themselves, and she despised their light talk. She resented visits to the nursery from Mrs. Darling's friends, but if they did come she first whipped off Michael's pinafore and put him into the one with blue braiding, and smoothed out Wendy and made a dash at John's hair. No nursery could possibly have been conducted more correctly, and Mr. Darling knew it, yet he sometimes wondered uneasily whether the neighbours talked. He had his position in the city to consider. Nana also troubled him in another way. He had sometimes a feeling that she did not admire him. "I know she admires you tremendously, George," Mrs. Darling would assure him, and then she would sign to the children to be specially nice to father. Lovely dances followed, in which the only other servant, Liza, was sometimes allowed to join. Such a midget she looked in her long skirt and maid's cap, though she had sworn, when engaged, that she would never see ten again. The gaiety of those romps! And gayest of all was Mrs. Darling, who would pirouette so wildly that all you could see of her was the kiss, and then if you had dashed at her you might have got it. There never was a simpler happier family until the coming of Peter Pan. Mrs. Darling first heard of Peter when she was tidying up her children's minds. It is the nightly custom of every good mother after her children are asleep to rummage in their minds and put things straight for next morning, repacking into their proper places the many articles that have wandered during the day. If you could keep awake (but of course you can't) you would see your own mother doing this, and you would find it very interesting to watch her. It is quite like tidying up drawers. You would see her on her knees, I expect, lingering humorously over some of your contents, wondering where on earth you had picked this thing up, making discoveries sweet and not so sweet, pressing this to her cheek as if it were as nice as a kitten, and hurriedly stowing that out of sight. When you wake in the morning, the naughtiness and evil passions with which you went to bed have been folded up small and placed at the bottom of your mind and on the top, beautifully aired, are spread out your prettier thoughts, ready for you to put on. I don't know whether you have ever seen a map of a person's mind. Doctors sometimes draw maps of other parts of you, and your own map can become intensely interesting, but catch them trying to draw a map of a child's mind, which is not only confused, but keeps going round all the time. There are zigzag lines on it, just like your temperature on a card, and these are probably roads in the island, for the Neverland is always more or less an island, with astonishing splashes of colour here and there, and coral reefs and rakish-looking craft in the offing, and savages and lonely lairs, and gnomes who are mostly tailors, and caves through which a river runs, and princes with six elder brothers, and a hut fast going to decay, and one very small old lady with a hooked nose. It would be an easy map if that were all, but there is also first day at school, religion, fathers, the round pond, needle-work, murders, hangings, verbs that take the dative, chocolate pudding day, getting into braces, say ninety-nine, three-pence for pulling out your tooth yourself, and so on, and either these are part of the island or they are another map showing through, and it is all rather confusing, especially as nothing will stand still.

Suffix Identification

Given a **prefix**, does the language model prefer the **gold suffix** over a **random suffix from same book?**

- Negatives often have high likelihood in isolation (common words etc.)
- LMs ignore prefix (longer-term context) in favor of local context

RankGen: Encouraging language models to use distant prefix

Prefixes

Suffixes

He sat on the edge of Mrs. Darling's bed, holding her hand and calculating expenses, while she looked at him imploringly. She wanted to risk it, come what might, but that was not his way; his way was with a pencil and a piece of paper, and if she confused him with suggestions he had to begin at the beginning again. "Now don't interrupt," he would beg of her. "I have one pound seventeen here, and two and six at the office; I can cut off my coffee at the office, say ten shillings, making two nine and six, with your eighteen and three makes three nine seven, with five naught naught in my cheque-book makes eight nine seven—who is that moving?—eight nine seven, dot and carry seven—don't speak, my own—and the pound you lent to that man who came to the door—quiet, child—dot and carry child—there, you've done it!—did I say nine nine seven? yes, I said nine nine seven; the question is, can we try it for a year on nine nine seven?"

"Of course we can, George," she cried. But she was prejudiced in Wendy's favour, and he was really the grander character of the two. "Remember mumps," he warned her almost threateningly, and off he went again. "Mumps one pound, that is what I have put down, but I daresay it will be more like thirty shillings—don't speak—measles one five, German measles half a guinea, makes two fifteen six—don't waggle your finger—whooping-cough, say fifteen shillings"—and so on it went, and it added up differently each time; but at last Wendy just got through, with mumps reduced to twelve six, and the two kinds of measles treated as one. There was the same excitement over John, and Michael had even a narrower squeak; but both were kept, and soon, you might have seen the three of them going in a row to Miss Fulsom's Kindergarten school, accompanied by their nurse.

Mrs. Darling loved to have everything just so, and Mr. Darling had a passion for being exactly like his neighbours; so, of course, they had a nurse. As they were poor, owing to the amount of milk the children drank, this nurse was a prim Newfoundland dog, called Nana, who had belonged to no one in particular until the Darlings engaged her. She had always thought children important, however, and the Darlings had become acquainted with her in Kensington Gardens, where she spent most of her spare time peeping into perambulators, and was much hated by careless nursemaids, whom she followed to their homes and complained of to their mistresses. She proved to be quite a treasure of a nurse. How thorough she was at bath-time, and up at any moment of the night if one of her charges made the slightest cry. Of course her kennel was in the nursery.

It was a lesson in propriety to see her escorting the children to school, walking sedately by their side when they were well behaved, and butting them back into line if they strayed. On John's footer days she never once forgot his sweater, and she usually carried an umbrella in her mouth in case of rain. There is a room in the basement of Miss Fulsom's school where the nurses wait. They sat on forms, while Nana lay on the floor, but that was the only difference. They affected to ignore her as of an inferior social status to themselves, and she despised their light talk. She resented visits to the nursery from Mrs. Darling's friends, but if they did come she first whipped off Michael's pinafore and put him into the one with blue braiding, and smoothed out Wendy and made a dash at John's hair. No nursery could possibly have been conducted more correctly, and Mr. Darling knew it, yet he sometimes wondered uneasily whether the neighbours talked. He had his position in the city to consider.

"Of course we can, George," she cried. But she was prejudiced in Wendy's favour, and he was really the grander character of the two. "Remember mumps," he warned her almost threateningly, and off he went again. "Mumps one pound, that is what I have put down, but I daresay it will be more like thirty shillings—don't speak—measles one five, German measles half a guinea, makes two fifteen six—don't waggle your finger—whooping-cough, say fifteen shillings"—and so on it went, and it added up differently each time; but at last Wendy just got through, with mumps reduced to twelve six, and the two kinds of measles treated as one. There was the same excitement over John, and Michael had even a narrower squeak; but both were kept, and soon, you might have seen the three of them going in a row to Miss Fulsom's Kindergarten school, accompanied by their nurse.

Mrs. Darling loved to have everything just so, and Mr. Darling had a passion for being exactly like his neighbours; so, of course, they had a nurse. As they were poor, owing to the amount of milk the children drank, this nurse was a prim Newfoundland dog, called Nana, who had belonged to no one in particular until the Darlings engaged her. She had always thought children important, however, and the Darlings had become acquainted with her in Kensington Gardens, where she spent most of her spare time peeping into perambulators, and was much hated by careless nursemaids, whom she followed to their homes and complained of to their mistresses. She proved to be quite a treasure of a nurse. How thorough she was at bath-time, and up at any moment of the night if one of her charges made the slightest cry. Of course her kennel was in the nursery.

She had a genius for knowing when a cough is a thing to have no patience with and when it needs stocking around your throat. She believed to her last day in old-fashioned remedies like rhubarb leaf, and made sounds of contempt over all this new-fangled talk about germs, and so on. It was a lesson in propriety to see her escorting the children to school, walking sedately by their side when they were well behaved, and butting them back into line if they strayed. On John's footer days she never once forgot his sweater, and she usually carried an umbrella in her mouth in case of rain. There is a room in the basement of Miss Fulsom's school where the nurses wait. They sat on forms, while Nana lay on the floor, but that was the only difference. They affected to ignore her as of an inferior social status to themselves, and she despised their light talk.

Nana also troubled him in another way. He had sometimes a feeling that she did not admire him. "I know she admires you tremendously, George," Mrs. Darling would assure him, and then she would sign to the children to be specially nice to father. Lovely dances followed, in which the only other servant, Liza, was sometimes allowed to join. Such a midget she looked in her long skirt and maid's cap, though she had sworn, when engaged, that she would never see ten again. The gaiety of those romps! And gayest of all was Mrs. Darling, who would pirouette so wildly that all you could see of her was the kiss, and then if you had dashed at her you might have got it. There never was a simpler happier family until the coming of Peter Pan. Mrs. Darling first heard of Peter when she was tidying up her children's minds.

.....

.....

RankGen: Encouraging language models to use distant prefix

PRE He sat on the edge of Mrs. Darling's bed, holding her hand and calculating expenses, while she looked at him imploringly. She wanted to risk it, come what might, but that was not his way; his way was with a pencil and a piece of paper, and if she confused him with suggestions he had to begin at the beginning again. "Now don't interrupt," he would beg of her. "I have one pound seventeen here, and two and six at the office; I can cut off my coffee at the office, say ten shillings, making two nine and six, with your eighteen and three makes three nine seven, with five naught naught in my cheque-book makes eight nine seven—who is that moving?—eight nine seven, dot and carry seven—don't speak, my own—and the pound you lent to that man who came to the door—quiet, child—dot and carry child—there, you've done it!—did I say nine nine seven? yes, I said nine nine seven; the question is, can we try it for a year on nine nine seven?"

PRE "Of course we can, George," she cried. But she was prejudiced in Wendy's favour, and he was really the grander character of the two. "Remember mumps," he warned her almost threateningly, and off he went again. "Mumps one pound, that is what I have put down, but I daresay it will be more like thirty shillings—don't speak—measles one five, German measles half a guinea, makes two fifteen six—don't waggle your finger—whooping-cough, say fifteen shillings"—and so on it went, and it added up differently each time; but at last Wendy just got through, with mumps reduced to twelve six, and the two kinds of measles treated as one. There was the same excitement over John, and Michael had even a narrower squeak; but both were kept, and soon, you might have seen the three of them going in a row to Miss Fulsom's Kindergarten school, accompanied by their nurse.

PRE Mrs. Darling loved to have everything just so, and Mr. Darling had a passion for being exactly like his neighbours; so, of course, they had a nurse. As they were poor, owing to the amount of milk the children drank, this nurse was a prim Newfoundland dog, called Nana, who had belonged to no one in particular until the Darlings engaged her. She had always thought children important, however, and the Darlings had become acquainted with her in Kensington Gardens, where she spent most of her spare time peeping into perambulators, and was much hated by careless nursemaids, whom she followed to their homes and complained of to their mistresses. She proved to be quite a treasure of a nurse. How thorough she was at bath-time, and up at any moment of the night if one of her charges made the slightest cry. Of course her kennel was in the nursery.

PRE It was a lesson in propriety to see her escorting the children to school, walking sedately by their side when they were well behaved, and butting them back into line if they strayed. On John's footer days she never once forgot his sweater, and she usually carried an umbrella in her mouth in case of rain. There is a room in the basement of Miss Fulsom's school where the nurses wait. They sat on forms, while Nana lay on the floor, but that was the only difference. They affected to ignore her as of an inferior social status to themselves, and she despised their light talk. She resented visits to the nursery from Mrs. Darling's friends, but if they did come she first whipped off Michael's pinafore and put him into the one with blue braiding, and smoothed out Wendy and made a dash at John's hair. No nursery could possibly have been conducted more correctly, and Mr. Darling knew it, yet he sometimes wondered uneasily whether the neighbours talked. He had his position in the city to consider.

SUF "Of course we can, George," she cried. But she was prejudiced in Wendy's favour, and he was really the grander character of the two. "Remember mumps," he warned her almost threateningly, and off he went again. "Mumps one pound, that is what I have put down, but I daresay it will be more like thirty shillings—don't speak—measles one five, German measles half a guinea, makes two fifteen six—don't waggle your finger—whooping-cough, say fifteen shillings"—and so on it went, and it added up differently each time; but at last Wendy just got through, with mumps reduced to twelve six, and the two kinds of measles treated as one. There was the same excitement over John, and Michael had even a narrower squeak; but both were kept, and soon, you might have seen the three of them going in a row to Miss Fulsom's Kindergarten school, accompanied by their nurse.

SUF Mrs. Darling loved to have everything just so, and Mr. Darling had a passion for being exactly like his neighbours; so, of course, they had a nurse. As they were poor, owing to the amount of milk the children drank, this nurse was a prim Newfoundland dog, called Nana, who had belonged to no one in particular until the Darlings engaged her. She had always thought children important, however, and the Darlings had become acquainted with her in Kensington Gardens, where she spent most of her spare time peeping into perambulators, and was much hated by careless nursemaids, whom she followed to their homes and complained of to their mistresses. She proved to be quite a treasure of a nurse. How thorough she was at bath-time, and up at any moment of the night if one of her charges made the slightest cry. Of course her kennel was in the nursery.

SUF She had a genius for knowing when a cough is a thing to have no patience with and when it needs stocking around your throat. She believed to her last day in old-fashioned remedies like rhubarb leaf, and made sounds of contempt over all this new-fangled talk about germs, and so on. It was a lesson in propriety to see her escorting the children to school, walking sedately by their side when they were well behaved, and butting them back into line if they strayed. On John's footer days she never once forgot his sweater, and she usually carried an umbrella in her mouth in case of rain. There is a room in the basement of Miss Fulsom's school where the nurses wait. They sat on forms, while Nana lay on the floor, but that was the only difference. They affected to ignore her as of an inferior social status to themselves, and she despised their light talk.

SUF Nana also troubled him in another way. He had sometimes a feeling that she did not admire him. "I know she admires you tremendously, George," Mrs. Darling would assure him, and then she would sign to the children to be specially nice to father. Lovely dances followed, in which the only other servant, Liza, was sometimes allowed to join. Such a midget she looked in her long skirt and maid's cap, though she had sworn, when engaged, that she would never see ten again. The gaiety of those romps! And gayest of all was Mrs. Darling, who would pirouette so wildly that all you could see of her was the kiss, and then if you had dashed at her you might have got it. There never was a simpler happier family until the coming of Peter Pan. Mrs. Darling first heard of Peter when she was tidying up her children's minds.

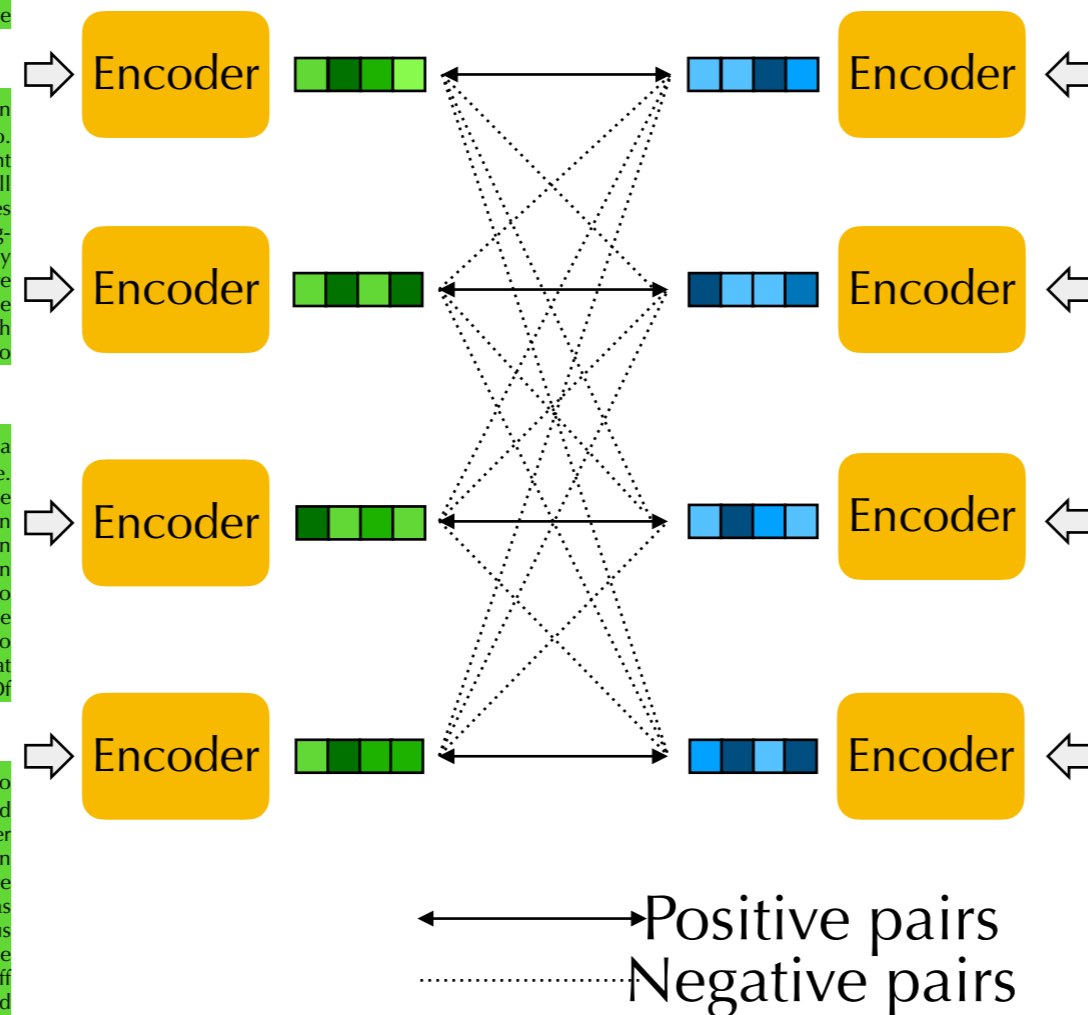

NOTATION

$p \rightarrow$ prefix

$s \rightarrow$ suffix

$B \rightarrow$ minibatch from same book $(p_i, s_i) \Big|_{i=1}^{|B|}$

ENCODING

$\mathbf{p}_i = \text{encoder}(\text{"pre"} + p_i)[0]$

$\mathbf{s}_i = \text{encoder}(\text{"suf"} + s_i)[0]$

LOSS FUNCTION

$$P_{lm}(s_i | p_i) = \frac{\exp \mathbf{p}_i \cdot \mathbf{s}_i}{\sum_{j=1}^{|B|} \exp \mathbf{p}_i \cdot \mathbf{s}_j}$$

positive pair
negative pairs

$$\text{loss} = - \sum_{i=1}^{|B|} \log P_{lm}(s_i | p_i)$$

Model	Batch Size	Parameters
RANKGEN-base	4096	110.2M
RANKGEN-large	4096	342.3M
RANKGEN-XL	1536	1.2B

Sohn 2016, Improved Deep Metric Learning with Multi-class N-pair Loss Objective

Radford et al. 2021, CLIP

Chen et al, 2020, SimCLR

NOTATION

$p \rightarrow$ prefix

$s \rightarrow$ suffix

$g \rightarrow$ causal LM generation

$B \rightarrow$ minibatch from same book $(p_i, s_i, g_i) \Big|_{i=1}^{|B|}$

ENCODING

$\mathbf{p}_i = \text{encoder}(\text{"pre"} + p_i)[0]$

$\mathbf{s}_i = \text{encoder}(\text{"suf"} + s_i)[0]$

$\mathbf{g}_i = \text{encoder}(\text{"suf"} + g_i)[0]$

LOSS FUNCTION

$$P_{lm}(s_i | p_i) = \frac{\exp \mathbf{p}_i \cdot \mathbf{s}_i}{\sum_{j=1}^{|B|} \exp \mathbf{p}_i \cdot \mathbf{s}_j + \exp \mathbf{p}_i \cdot \mathbf{g}_j}$$

$$\text{loss} = - \sum_{i=1}^{|B|} \log P_{lm}(s_i | p_i)$$

Sohn 2016, Improved Deep Metric Learning with Multi-class N-pair Loss Objective

Radford et al. 2021, CLIP

Chen et al, 2020, SimCLR

RankGen: “K-word language modeling”

PRE He sat on the edge of Mrs. Darling’s bed, holding her hand and calculating expenses, while she looked at him imploringly. She wanted to risk it, come what might, but that was not his way; his way was with a pencil and a piece of paper, and if she confused him with suggestions he had to begin at the beginning again. “Now don’t interrupt,” he would beg of her. “I have one pound seventeen here, and two and six at the office; I can cut off my coffee at the office, say ten shillings, making two nine and six, with your eighteen and three makes three nine seven, with five naught naught in my cheque-book makes eight nine seven—who is that moving?—eight nine seven, dot and carry seven—don’t speak, my own—and the pound you lent to that man who came to the door—quiet, child—dot and carry child—there, you’ve done it!—did I say nine nine seven? yes, I said nine nine seven; the question is, can we try it for a year on nine nine seven?”

PRE “Of course we can, George,” she cried. But she was prejudiced in Wendy’s favour, and he was really the grander character of the two. “Remember mumps,” he warned her almost threateningly, and off he went again. “Mumps one pound, that is what I have put down, but I daresay it will be more like thirty shillings—don’t speak—measles one five, German measles half a guinea, makes two fifteen six—don’t waggle your finger—whooping-cough, say fifteen shillings”—and so on it went, and it added up differently each time; but at last Wendy just got through, with mumps reduced to twelve six, and the two kinds of measles treated as one. There was the same excitement over John, and Michael had even a narrower squeak; but both were kept, and soon, you might have seen the three of them going in a row to Miss Fulsom’s Kindergarten school, accompanied by their nurse.

PRE Mrs. Darling loved to have everything just so, and Mr. Darling had a passion for being exactly like his neighbours; so, of course, they had a nurse. As they were poor, owing to the amount of milk the children drank, this nurse was a prim Newfoundland dog, called Nana, who had belonged to no one in particular until the Darlings engaged her. She had always thought children important, however, and the Darlings had become acquainted with her in Kensington Gardens, where she spent most of her spare time peeping into perambulators, and was much hated by careless nursemaids, whom she followed to their homes and complained of to their mistresses. She proved to be quite a treasure of a nurse. How thorough she was at bath-time, and up at any moment of the night if one of her charges made the slightest cry. Of course her kennel was in the nursery.

PRE It was a lesson in propriety to see her escorting the children to school, walking sedately by their side when they were well behaved, and butting them back into line if they strayed. On John’s footer days she never once forgot his sweater, and she usually carried an umbrella in her mouth in case of rain. There is a room in the basement of Miss Fulsom’s school where the nurses wait. They sat on forms, while Nana lay on the floor, but that was the only difference. They affected to ignore her as of an inferior social status to themselves, and she despised their light talk. She resented visits to the nursery from Mrs. Darling’s friends, but if they did come she first whipped off Michael’s pinafore and put him into the one with blue braiding, and smoothed out Wendy and made a dash at John’s hair. No nursery could possibly have been conducted more correctly, and Mr. Darling knew it, yet he sometimes wondered uneasily whether the neighbours talked. He had his position in the city to consider.

SUF “Of course we can, George,” she cried. But she was prejudiced in Wendy’s favour, and he was really the grander character of the two. “Remember mumps,” he warned her almost threateningly, and off he went again. “Mumps one pound, that is what I have put down, but I daresay it will be more like thirty shillings—don’t speak—measles one five, German measles half a guinea, makes two fifteen six—don’t waggle your finger—whooping-cough, say fifteen shillings”—and so on it went, and it added up differently each time; but at last Wendy just got through, with mumps reduced to twelve six, and the two kinds of measles treated as one. There was the same excitement over John, and Michael had even a narrower squeak; but both were kept, and soon, you might have seen the three of them going in a row to Miss Fulsom’s Kindergarten school, accompanied by their nurse.

SUF Mrs. Darling loved to have everything just so, and Mr. Darling had a passion for being exactly like his neighbours; so, of course, they had a nurse. As they were poor, owing to the amount of milk the children drank, this nurse was a prim Newfoundland dog, called Nana, who had belonged to no one in particular until the Darlings engaged her. She had always thought children important, however, and the Darlings had become acquainted with her in Kensington Gardens, where she spent most of her spare time peeping into perambulators, and was much hated by careless nursemaids, whom she followed to their homes and complained of to their mistresses. She proved to be quite a treasure of a nurse. How thorough she was at bath-time, and up at any moment of the night if one of her charges made the slightest cry. Of course her kennel was in the nursery.

SUF She had a genius for knowing when a cough is a thing to have no patience with and when it needs stocking around your throat. She believed to her last day in old-fashioned remedies like rhubarb leaf, and made sounds of contempt over all this new-fangled talk about germs, and so on. It was a lesson in propriety to see her escorting the children to school, walking sedately by their side when they were well behaved, and butting them back into line if they strayed. On John’s footer days she never once forgot his sweater, and she usually carried an umbrella in her mouth in case of rain. There is a room in the basement of Miss Fulsom’s school where the nurses wait. They sat on forms, while Nana lay on the floor, but that was the only difference. They affected to ignore her as of an inferior social status to themselves, and she despised their light talk.

SUF Nana also troubled him in another way. He had sometimes a feeling that she did not admire him. “I know she admires you tremendously, George,” Mrs. Darling would assure him, and then she would sign to the children to be specially nice to father. Lovely dances followed, in which the only other servant, Liza, was sometimes allowed to join. Such a midget she looked in her long skirt and maid’s cap, though she had sworn, when engaged, that she would never see ten again. The gaiety of those romps! And gayest of all was Mrs. Darling, who would pirouette so wildly that all you could see of her was the kiss, and then if you had dashed at her you might have got it. There never was a simpler happier family until the coming of Peter Pan. Mrs. Darling first heard of Peter when she was tidying up her children’s minds.

$$P(s | p_i) = \text{softmax}(S p_i)$$

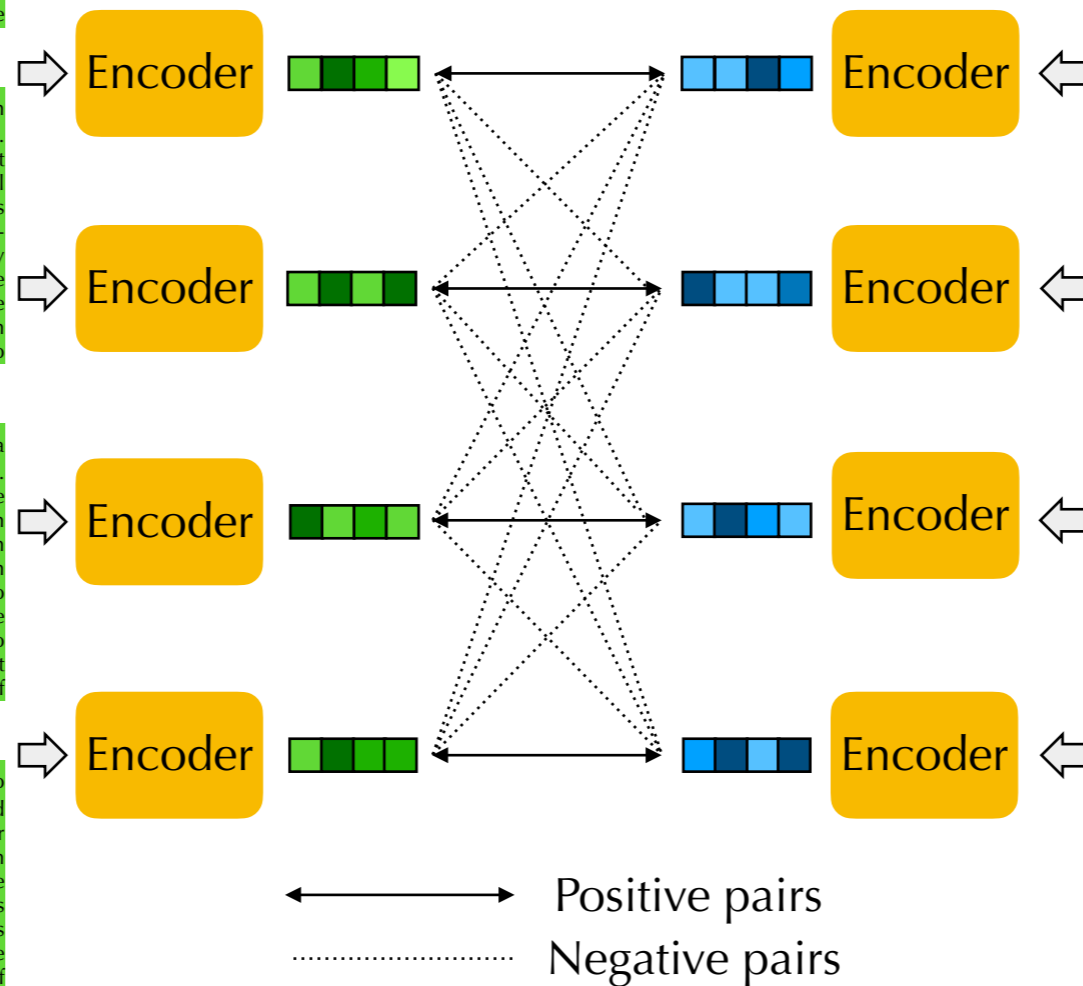

Inference with RankGen

Strategy 1: over-generate and re-rank with RankGen

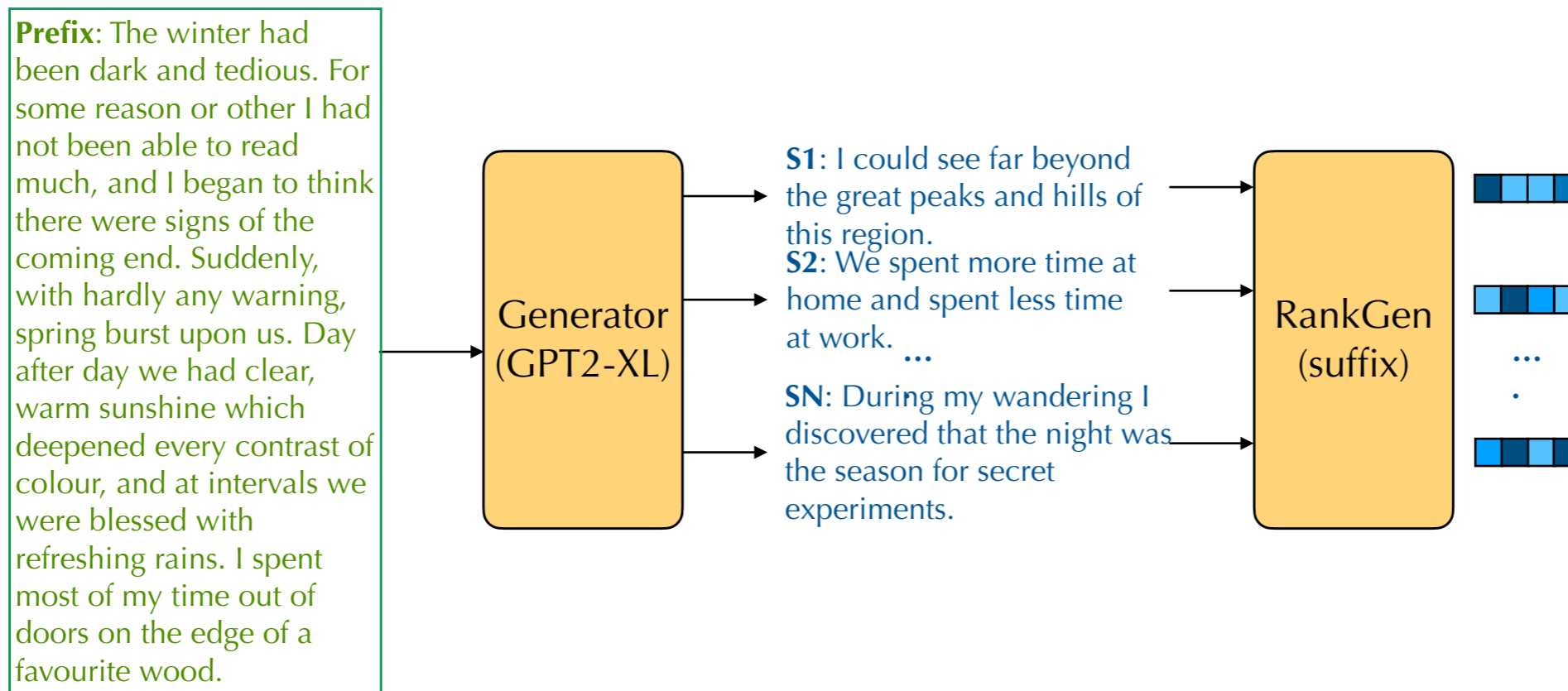

Inference with RankGen

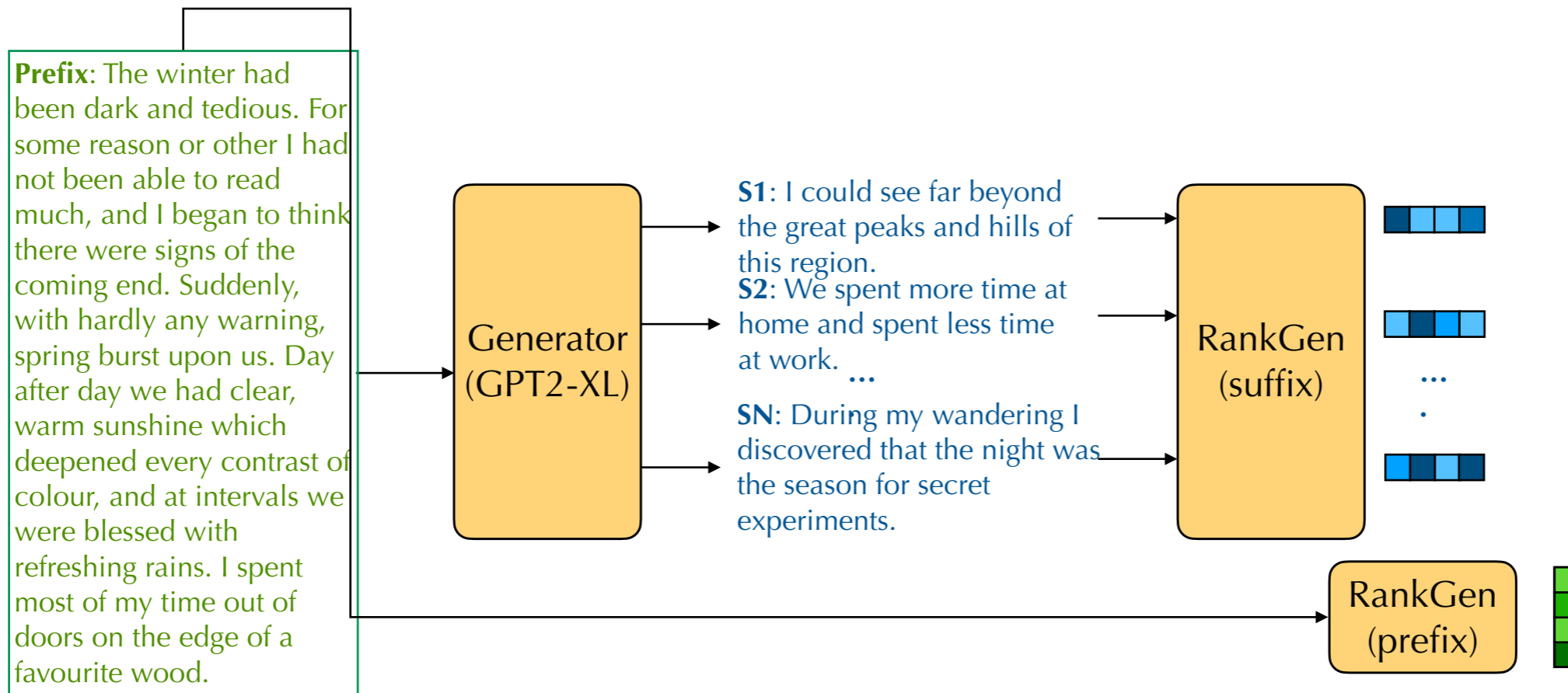

Inference with RankGen

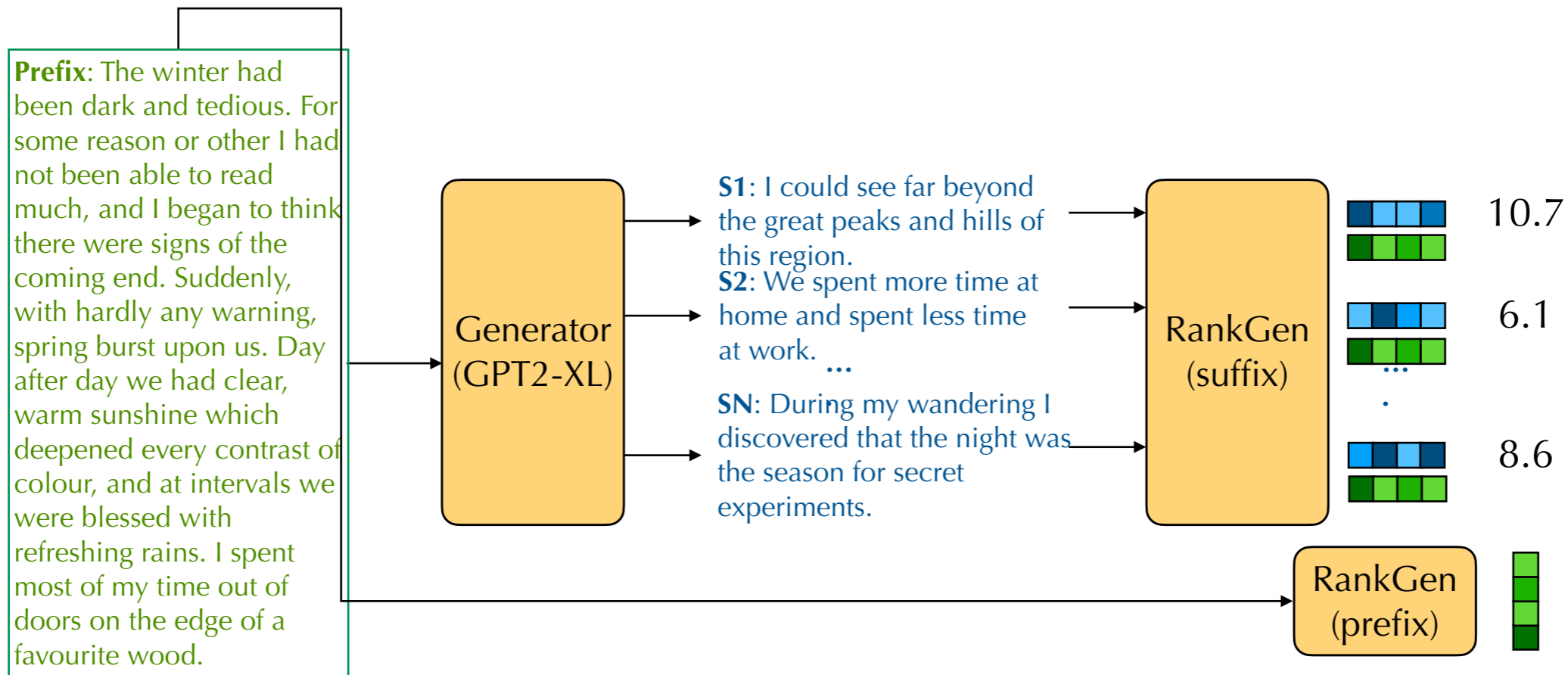

Inference with RankGen

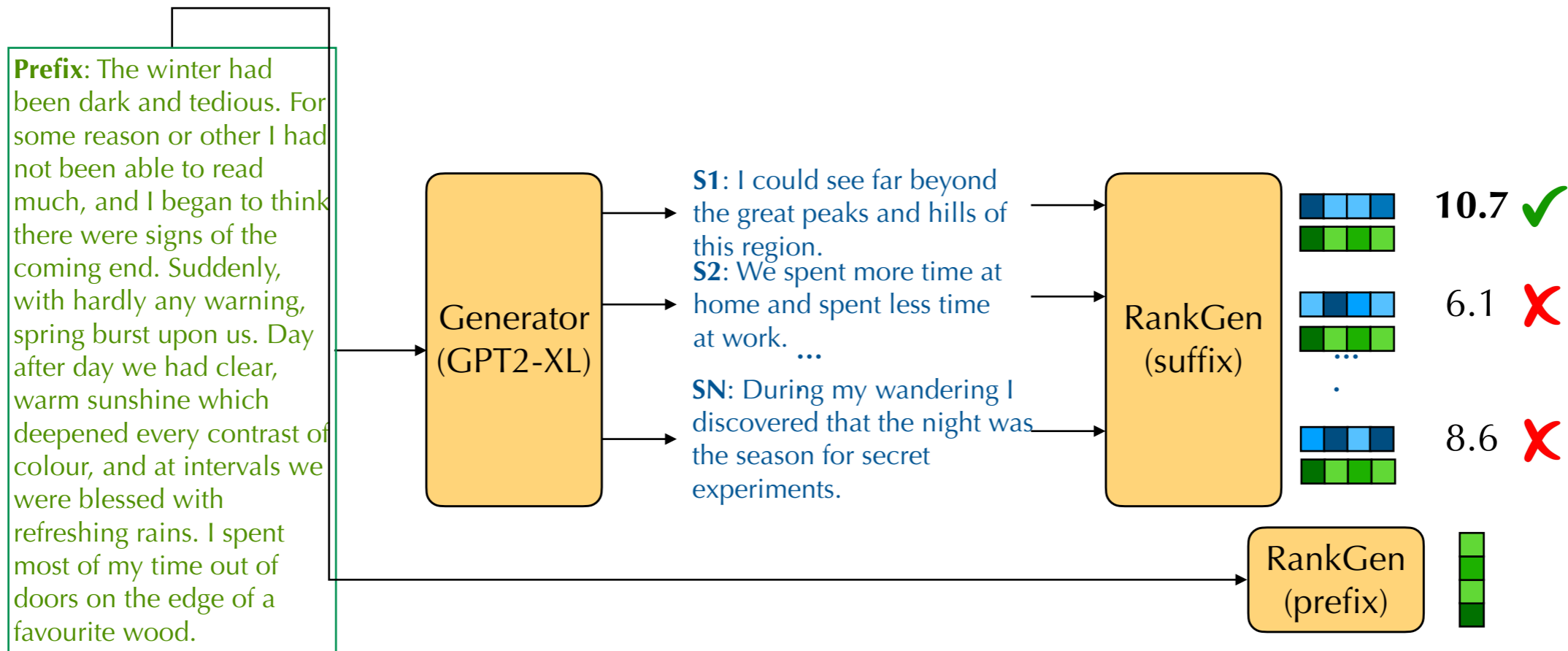

Inference with RankGen — beam search

Strategy 2: RankGen as a beam search scoring function

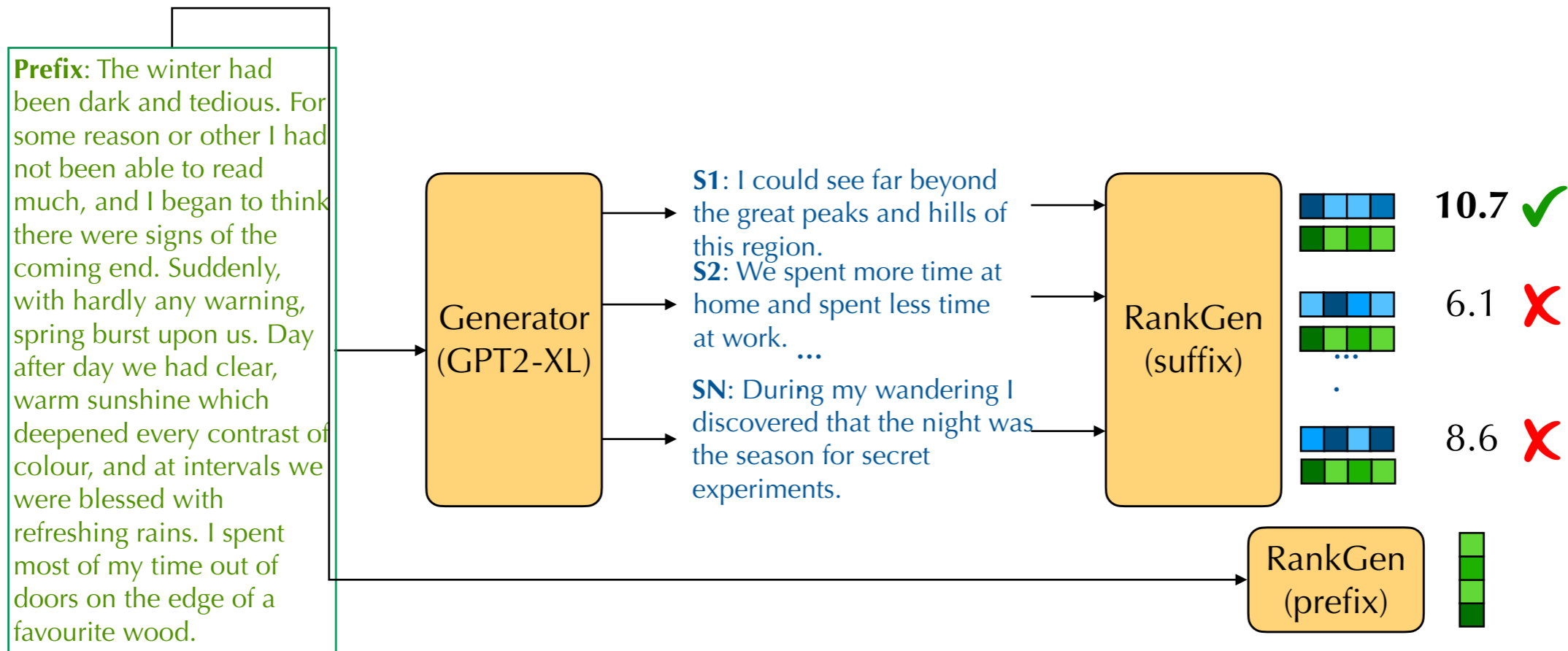

Inference with RankGen — beam search

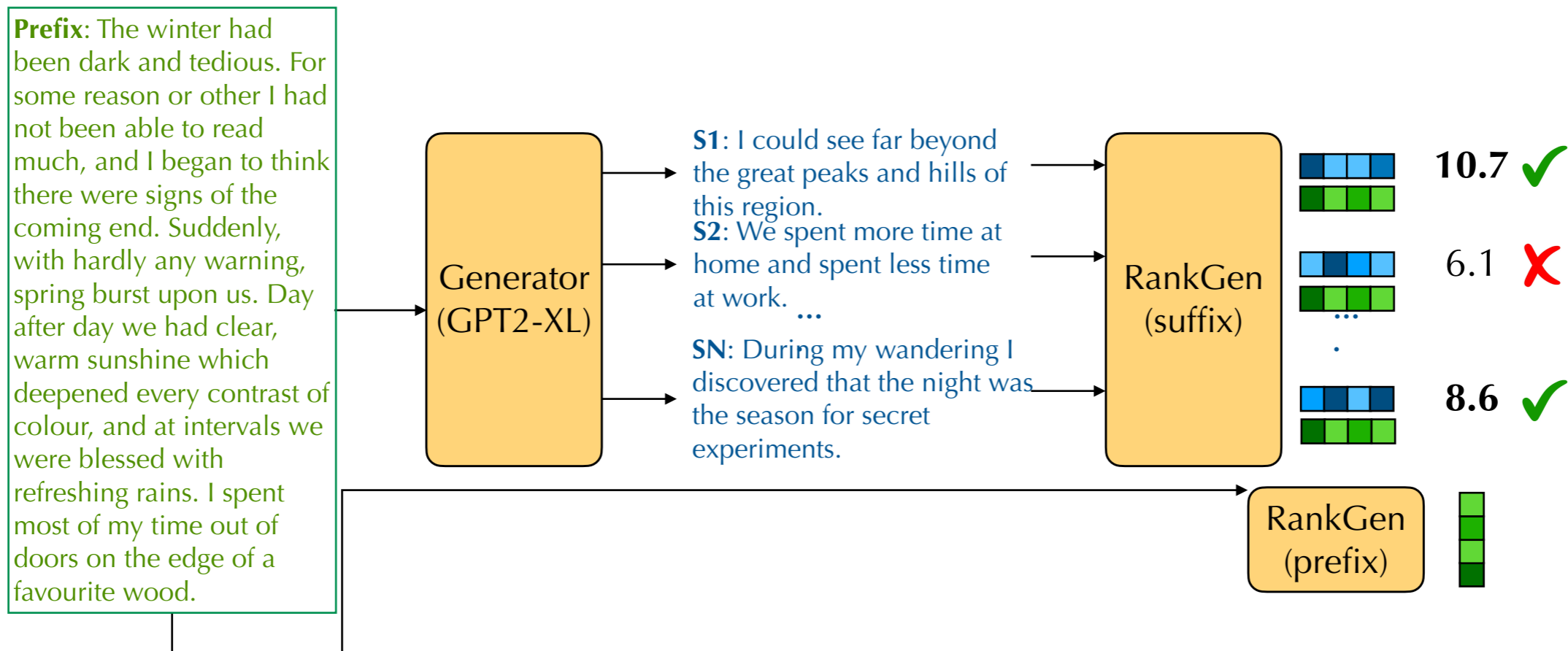

Inference with RankGen — beam search

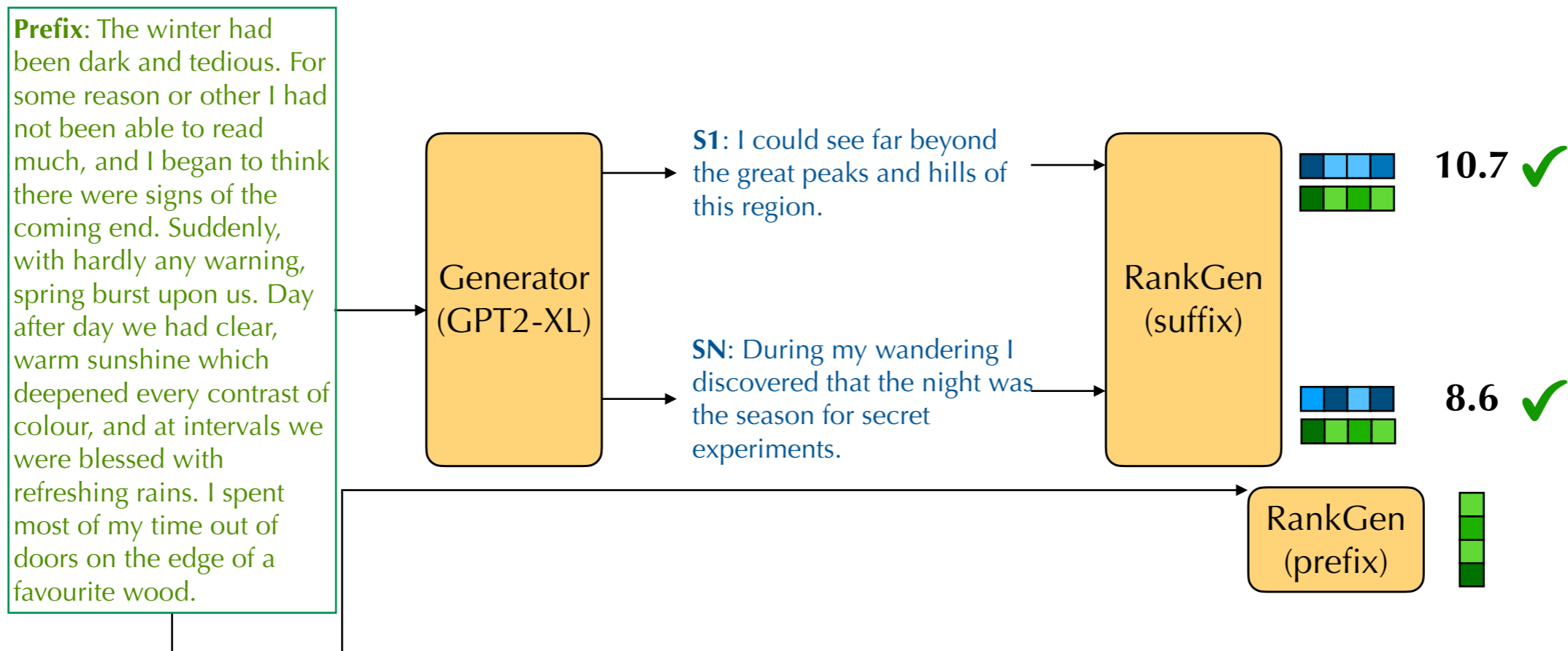

Inference with RankGen — beam search

Prefix: The winter had been dark and tedious. For some reason or other I had not been able to read much, and I began to think there were signs of the coming end. Suddenly, with hardly any warning, spring burst upon us. Day after day we had clear, warm sunshine which deepened every contrast of colour, and at intervals we were blessed with refreshing rains. I spent most of my time out of doors on the edge of a favourite wood.

S1: I could see far beyond the great peaks and hills of this region.

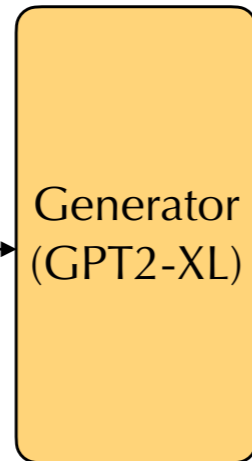

S1: The cold air in the woods would bite through my skin, causing me to stay indoors.
...

SN: The beautiful orange light of the sun would peep through the mountains.

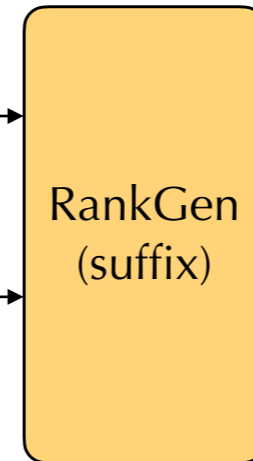

2.1



16.3

Prefix: The winter had been dark and tedious. For some reason or other I had not been able to read much, and I began to think there were signs of the coming end. Suddenly, with hardly any warning, spring burst upon us. Day after day we had clear, warm sunshine which deepened every contrast of colour, and at intervals we were blessed with refreshing rains. I spent most of my time out of doors on the edge of a favourite wood.

SN: During my wandering I discovered that the night was the season for secret experiments.

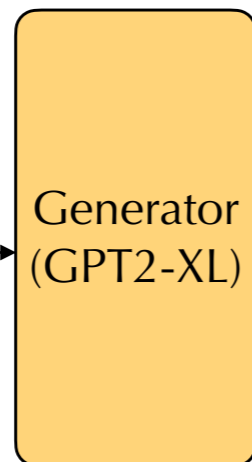

S1: One of my favourite experiments was observing owls hunting for food in the woods.
...

SN: I would sleep early, waiting for the sun to rise everyday.

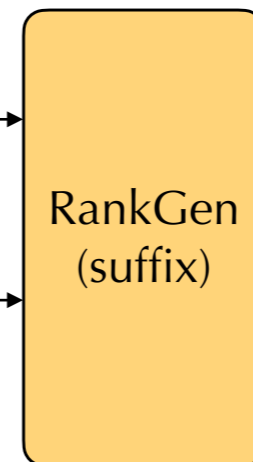

12.4



5.6

Inference with RankGen — beam search

Prefix: The winter had been dark and tedious. For some reason or other I had not been able to read much, and I began to think there were signs of the coming end. Suddenly, with hardly any warning, spring burst upon us. Day after day we had clear, warm sunshine which deepened every contrast of colour, and at intervals we were blessed with refreshing rains. I spent most of my time out of doors on the edge of a favourite wood.

S1: I could see far beyond the great peaks and hills of this region.

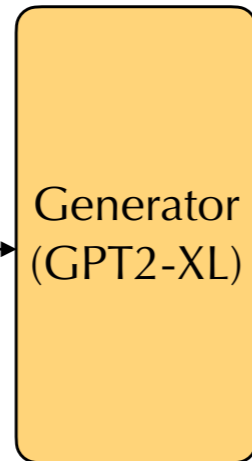

S1: The cold air in the woods would bite through my skin, causing me to stay indoors. ...
SN: The beautiful orange light of the sun would peep through the mountains.

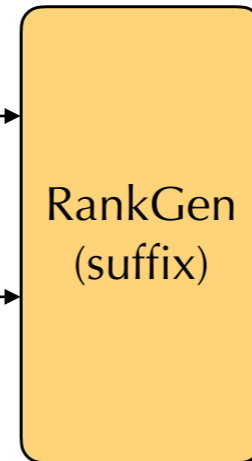

2.1 **X**
 16.3 **✓**

Prefix: The winter had been dark and tedious. For some reason or other I had not been able to read much, and I began to think there were signs of the coming end. Suddenly, with hardly any warning, spring burst upon us. Day after day we had clear, warm sunshine which deepened every contrast of colour, and at intervals we were blessed with refreshing rains. I spent most of my time out of doors on the edge of a favourite wood.

SN: During my wandering I discovered that the night was the season for secret experiments.

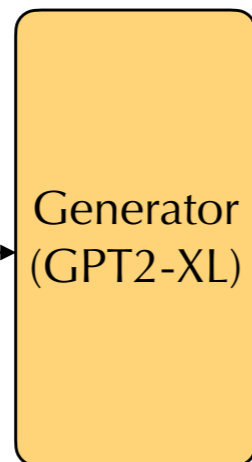

S1: One of my favourite experiments was observing owls hunting for food in the woods. ...
SN: I would sleep early, waiting for the sun to rise everyday.

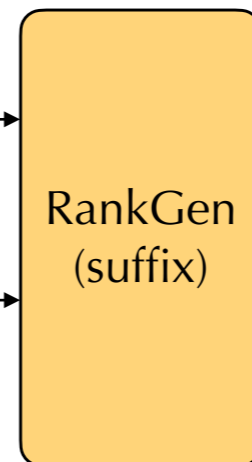

12.4 **✓**
 5.6 **X**

Experimental Setup

4 base LMs, 2 domains (PG19/Wiki)

Model	Parameters
GPT2-medium	0.3 billion
GPT2-XL	1.5 billion
T5-XXL-C4	11.0 billion
T5-XXL-PG19	11.0 billion
RankGen-XL	1.2 billion

Evaluation with MAUVE

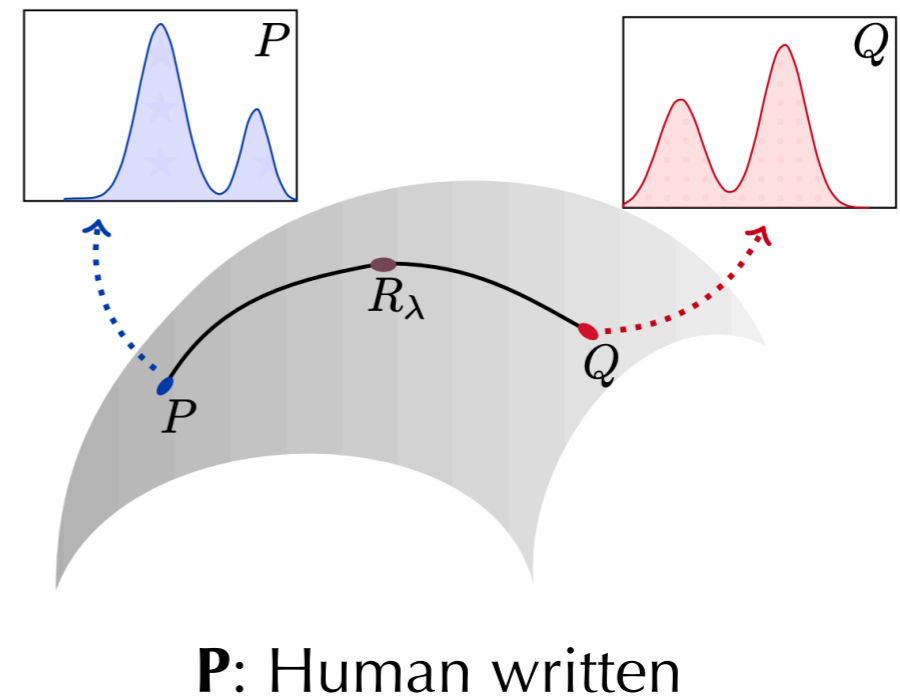

Comparing RankGen to other decoding strategies

Decoding strategy	Avg. MAUVE
Greedy Decoding	15.4
Ancestral Sampling	74.8
Nucleus Sampling (Holtzman et al. 2020)	77.3
Top-K Sampling (Fan et al. 2018)	77.4
Typical Sampling (Meister et al. 2022)	77.1
RankGen-XL (1.2B) + 20 ancestral samples	82.6
RankGen-XL (1.2B) + 20 nucleus samples	83.4
RankGen-XL (1.2B) + beam w/ nucleus	85.0

RankGen beats newer decoding algorithms as well!

Decoding Method	GPT2-md		GPT2-XL	
	PG19	wiki	PG19	wiki
Nucleus ($p = 0.9$)	73.0	74.6	74.4	75.0
Eta (Hewitt et al., 2022)	76.9	71.2	76.9	74.8
<i>Contrastive methods</i>				
search (Su et al., 2022)	5.3	21.2	54.0	43.2
decode (Li et al., 2022)	65.2	83.2	73.2	84.9
RANKGEN-all-XL (ours)				
rerank full ancestral	79.0	84.9	79.0	86.4
beam search nucleus	76.2	88.9	77.0	89.4

What do humans evaluators think about RankGen?

English writers: RankGen > nucleus sampling
75% times

Reasons relating the prefix with the generation (81%)

More topically relevant to the prefix	37.7%
Better continuity / flow / chronology	31.6%
Does not contradict prefix	6.8%
Stylistically closer to prefix	4.7%

Reasons related only to the generated text (19%)

Better commonsense understanding	8.0%
Less repetitive	4.7%
More grammatical	3.1%
Less contradictions	1.7%
More coherent / other	1.7%

Very easy to use RankGen!

Install `pip install rankgen`

Encode

```
from rankgen import RankGenEncoder, RankGenGenerator

rankgen_encoder = RankGenEncoder("kalpeshk2011/rankgen-t5-xl-all")

prefix_vectors = rankgen_encoder.encode(["This is a prefix sentence."], vectors_type="prefix")
suffix_vectors = rankgen_encoder.encode(["This is a suffix sentence."], vectors_type="suffix")
```

Generate

```
generator = RankGenGenerator(rankgen_encoder=rankgen_encoder, language_model="gpt2-medium")
inputs = ["Whatever might be the nature of the tragedy it would be over with long before this, and"]

print(generator.overgenerate_rerank(inputs, top_p=0.9, num_samples=10)[0][0])
print(generator.beam_search(inputs, top_p=0.9, num_samples=10, beam_size=2)[0][0])
```

Any causal LM on HuggingFace