

November 2016

Specification and Analysis of Resource Utilization Policies for Human-Intensive Systems

Seung Yeob Shin
University of Massachusetts - Amherst

Follow this and additional works at: https://scholarworks.umass.edu/dissertations_2



Part of the [Software Engineering Commons](#)

Recommended Citation

Shin, Seung Yeob, "Specification and Analysis of Resource Utilization Policies for Human-Intensive Systems" (2016). *Doctoral Dissertations*. 805.
https://scholarworks.umass.edu/dissertations_2/805

This Open Access Dissertation is brought to you for free and open access by the Dissertations and Theses at ScholarWorks@UMass Amherst. It has been accepted for inclusion in Doctoral Dissertations by an authorized administrator of ScholarWorks@UMass Amherst. For more information, please contact scholarworks@library.umass.edu.

**SPECIFICATION AND ANALYSIS OF RESOURCE UTILIZATION
POLICIES FOR HUMAN-INTENSIVE SYSTEMS**

A Dissertation Presented

by

SEUNG YEOB SHIN

Submitted to the Graduate School of the
University of Massachusetts Amherst in partial fulfillment
of the requirements for the degree of

DOCTOR OF PHILOSOPHY

September 2016

Computer Science

© Copyright by Seung Yeob Shin 2016

All Rights Reserved

**SPECIFICATION AND ANALYSIS OF RESOURCE UTILIZATION
POLICIES FOR HUMAN-INTENSIVE SYSTEMS**

A Dissertation Presented

by

SEUNG YEOP SHIN

Approved as to style and content by:

Leon J. Osterweil, Co-chair

Yuriy Brun, Co-chair

Lori A. Clarke, Member

George S. Avrunin, Member

Hari Balasubramanian, Member

James Allan, Chair of the Faculty
College of Information and Computer Sciences

DEDICATION

To my family

ACKNOWLEDGMENTS

First and foremost, I would like to express my sincere gratitude to my advisors: Leon J. Osterweil and Yuriy Brun. I am so fortunate to have had the excellent experience of benefiting from their advisorship concerning my graduate study and life. I have reached this point because of their encouragement, patience, advice, and all other support. I cannot imagine having better advisors and mentors for my graduate study.

I would also like to thank my committee members: Lori A. Clarke, George S. Avrunin, and Hari Balasubramanian. In addition, I am also grateful to my domain expert, Philip L. Henneman. Their valuable constructive feedback helped me improve the quality of my dissertation. I appreciate having the great opportunity to collaborate with these amazing researchers.

I also thank all members of the LASER lab at UMass Amherst. I really enjoyed working at the lab because of their efforts to create a friendly working environment. I especially thank Heather Conboy for her help in analyzing and extending the legacy source codes developed in the LASER lab.

I am grateful to all my friends in Amherst. I was able to enjoy life in Amherst because of them. The moments that we shared together are unforgettable and an exciting chapter in my life. I would like to especially thank David Nielsen for his support and advice about living in the USA.

Lastly, but most importantly, I would like to thank my family for all their love. My family has been encouraging, supportive and shown belief in me. I never would have been able to complete my thesis without their support. I'm especially thankful to my wife, Joo Yeon Ryu. I would not be the person I am today without your love. I love you.

ABSTRACT

SPECIFICATION AND ANALYSIS OF RESOURCE UTILIZATION POLICIES FOR HUMAN-INTENSIVE SYSTEMS

SEPTEMBER 2016

SEUNG YEOB SHIN

B.Sc., SOGANG UNIVERSITY, KOREA

M.Sc., POHANG UNIVERSITY OF SCIENCE AND TECHNOLOGY, KOREA

M.Sc., UNIVERSITY OF MASSACHUSETTS AMHERST

Ph.D., UNIVERSITY OF MASSACHUSETTS AMHERST

Directed by: Professor Leon J. Osterweil and Professor Yuriy Brun

Contemporary systems often require the effective support of many types of resources, each governed by complex utilization policies. Sound management of these resources plays a key role in assuring that these systems achieve their key goals. To help system developers make sound resource management decisions, I provide a resource utilization policy specification and analysis framework for (1) specifying very diverse kinds of resources and their potentially complex resource utilization policies, (2) dynamically evaluating the policies' effects on the outcomes achieved by systems utilizing the resources, and (3) formally verifying various kinds of properties of these systems.

Resource utilization policies range from simple, e.g., first-in-first-out, to extremely complex, responding to changes in system environment, state, and stimuli. Further, policies may at times conflict with each other, requiring conflict resolution strategies that add extra

complexity. Prior specification approaches rely on relatively simple resource models that prevent the specification of complex utilization and conflict resolution policies. My approach (1) separates resource utilization policy concerns from resource characteristic and request specifications, (2) creates an expressive specification notation for constraint policies, and (3) creates a resource constraint conflict resolution capability. My approach enables creating specifications of policies that are sufficiently precise and detailed to support static and dynamic analyses of how these policies affect the properties of systems constrained or governed by these policies.

I provide a process- and resource-aware discrete-event simulator for simulating system executions that adhere to policies of resource utilization. The simulator integrates the existing JSim simulation engine with a separate resource management system. The separate architectural component makes it easy to keep track of resource utilization traces during a simulation run. My simulation framework facilitates considerable flexibility in the evaluation of diverse resource management decisions and powerful dynamic analyses.

Dynamic verification through simulation is inherently limited because of the impossibility of exhaustive simulation of all scenarios. I complement this approach with static verification. Prior static resource analysis has supported the verification only of relatively simple resource utilization policies. My research utilizes powerful model checking techniques, building on the existing FLAVERS model checking tool, to verify properties of complex systems that are also verified to conform to complex resource utilization policies. My research demonstrates how to use systems such as FLAVERS to verify adherence to complex resource utilization policies as well as overall system properties, such as the absence of resource leak and resource deadlock.

I evaluated my approach working with a hospital emergency department domain expert, using detailed, expert-developed models of the processes and resource utilization policies of an emergency department. In doing this, my research demonstrates how my framework can be effective in guiding the domain expert towards making sound decisions about policies for

the management of hospital resources, while also providing rigorously-based assurances that the guidance is reliable and well-founded.

My research makes the following contributions: (1) a specification language for resources and resource utilization policies for human-intensive systems, (2) a process- and resource-aware discrete-event simulation engine that creates simulations that adhere to the resource utilization policies, allowing for the dynamic evaluation of resource utilization policies, (3) a process- and resource-aware model checking technique that formally verifies system properties and adherence to resource utilization policies, and (4) validated and verified specifications of an emergency department healthcare system, demonstrating the utility of my approach.

TABLE OF CONTENTS

	Page
ACKNOWLEDGMENTS	v
ABSTRACT	vi
LIST OF FIGURES	xii
 CHAPTER	
1. INTRODUCTION	1
1.1 Motivating Example	2
1.2 Contributions	3
2. RESOURCE MANAGEMENT ISSUES	5
2.1 Resource Characteristics	5
2.2 Resource Requests	6
2.3 Resource Utilization Policies	7
3. RESOURCE MODELING	9
3.1 Resource Characteristics	10
3.2 Resource Requests	15
3.3 Resource Utilization Policies	18
3.3.1 Permission Constraint Policy	18
3.3.2 Scheduling Policy	20
3.3.3 Conflict Resolution Policy	23
3.3.3.1 Priority Conflict Resolution	23
3.3.3.2 Case Conflict Resolution	25
4. DYNAMIC ANALYSIS THROUGH PROCESS- AND RESOURCE-AWARE DISCRETE-EVENT SIMULATION	28

4.1	Platform for Process- and Resource-Aware Discrete-Event Simulation	28
4.1.1	Little-JIL: Process Modeling	28
4.2	Process- and Resource-Aware Discrete-Event Simulator	31
4.2.1	Resource Manager Architecture	33
4.2.2	Specification of Simulation	35
4.3	Constraint-Aware Resource Scheduling	36
4.3.1	Simulation-based Staffing Optimization	36
4.3.1.1	Simulation-based Resource Requirement Determination	38
4.3.1.2	Staffing via Integer Linear Programming (ILP)	41
5.	STATIC ANALYSIS THROUGH PROCESS- AND RESOURCE-AWARE MODEL CHECKING	47
5.1	Resource-Aware Static Analysis	47
5.2	Platform for Process- and Resource-Aware Finite State Verification	50
5.2.1	FLAVERS: FLOW Analysis for VERification of Systems	50
5.2.2	BIR: Bandera Intermediate Representation	51
5.2.3	XPath: XML Path Language	52
5.3	Process- and Resource-Aware Model Checking	54
5.3.1	BIR Translation Templates Encoding Resource Utilization	56
5.3.1.1	BIR Template: Single Resource Allocation	56
5.3.1.2	BIR Template: Single Resource Release	58
5.3.1.3	BIR Template: Multiple Resource Allocations	60
5.3.1.4	BIR Template: Multiple Resource Releases	62
5.3.1.5	BIR Template: Permission Constraint Policy	63
5.3.1.6	BIR Template: Priority Conflict Resolution Policy	64
5.3.1.7	BIR Template: Case Conflict Resolution Policy	66
5.3.2	Trace Flow Graph Encoding Resource Utilization	66
5.3.3	Resource Constraint Finite State Machine	69
5.3.4	Resource Property Finite State Machine	73
5.3.5	Reachability Analysis for Resource Utilization	75
6.	EVALUATION	79
6.1	Resource Modeling	79

6.1.1	Patient Care Model Comparison	80
6.2	Process- and Resource-Aware Discrete-Event Simulation	83
6.2.1	Impact of Shift Length and Overlap	85
6.2.2	Comparison with Baystate Staffing Schedule	89
6.3	Process- and Resource-Aware Model Checking	90
6.3.1	Verification of Adherence to Resource Utilization Policy	91
6.3.2	Reachability Analysis	95
6.3.3	Scalability Characteristics.....	99
7.	RELATED WORK	105
7.1	Modeling	105
7.1.1	Process Modeling	105
7.1.2	Policy Modeling.....	108
7.2	Simulations	109
7.2.1	Simulations Tools	110
7.2.2	Hospital Patient Care Simulations	112
7.3	Static Analysis	112
7.3.1	Formal Verification Tools	113
7.3.2	Static Resource Analysis.....	113
7.4	Resource Management	116
7.4.1	Resource Management in Operating Systems	116
7.4.2	Resource Management in Clouding Systems	117
8.	CONCLUSIONS	118
8.1	Discussions	118
8.2	Future Work.....	119
	BIBLIOGRAPHY	125

LIST OF FIGURES

Figure	Page
3.1 The structure of resource characteristics describes the static relations of the entities that define a resource type. Cardinality $1..n$ denotes one or n numbers. Cardinality $0..*$ represents zero or more.	10
3.2 An example of doctor resource type <i>MD</i> for the process of treating patients.	13
3.3 Example states of six resource objects of <i>MD</i> type working during different shifts at a system state of a patient care process in a hospital ED.	14
3.4 The structure of a resource request describes the static relations of the entities that define a resource request.	15
3.5 Examples of resource requests from patient care activities in a hospital ED.	17
3.6 The structure of the resource utilization policy specification describes the static relations between the policy's entities.	18
3.7 Examples of permission constraint policies in a patient care process in a hospital ED.	19
3.8 An example of a contention policy in a hospital ED. This example includes only the key features specifications.	21
3.9 An example of a selection policy in a hospital ED. This example includes only the key features specifications.	22
3.10 An example of priority conflict resolution policy in a hospital ED. This example include only the key features specifications.	24
3.11 An example of a case conflict resolution policy in a hospital ED. This example includes only the key features specifications.	26
4.1 The Little-JIL definition of the patient testing process, which is part of the care an acuity-level-four patient undergoes in an ED	29

4.2	A view of the process- and resource-aware simulator that integrates JSim and Resource Manager.	32
4.3	A resource manager architecture that enforces the specified resource utilization policies while allocating resources.	33
4.4	These time distributions of steps are modeled from data of Baystate Medical Center, in Springfield, MA, USA. Second time unit is used in triangular distribution.	35
4.5	Given the upper and lower utilization limits, the algorithm calculates how many resources of type k are required during time block $b = (t - i, t)$ and adjusts the number of available resources of type k to be assigned for next time block $nb = (t, t + i)$	40
4.6	An instance of the algorithm execution for staffing demands: $R_b^k = \{r_1, r_2, r_3\}$, $A_b^k = \{r_2, r_3\}$, $d_b^k = 3$, $R_{nb}^k = \{r_2, r_3, r_4, r_5\}$, $A_{nb}^k = \{r_3, r_4, r_5\}$ where $b = (t - i, t)$, $nb = (t, t + i)$	41
4.7	Parameter values for MD staffing. B : twenty four time blocks. L^{MD} : 8-hour shift length. $S_{b,l}^{MD}$: time blocks in l length shift b . d_b^{MD} : staffing demands per each time blocks driven by 70%–80% utilization target. $p_{b,l}^{MD}$: non-overlapped three, 8-hour shifts. c^{MD} : salary per hour.	43
4.8	Parameter values for RN staffing. B : twenty four time blocks. L^{RN} : 6,8,12-hour shift lengths. $S_{b,l}^{RN}$: time blocks in l length shift b . d_b^{RN} : staffing demands per each time blocks driven by 60%–70% utilization target. $p_{b,l}^{RN}$: three different shift lengths, and the staffing pattern allows a shift to start at any time. c^{RN} : salary per hour.	44
4.9	MD staffing solution of Figure 4.7. Three separate shifts, 7–14, 15–22 and 23–6. Each shift has 9, 8 or 8 MDs.	45
4.10	RN staffing solution of Figure 4.8. Sixteen overlapped shifts. Shifts have different lengths and start times. Total number of RNs 46 and RNs working hours 392.	46
5.1	An example that shows the difference in verification results between the analysis technique C and R . C -the property does not hold. R -the property holds.	48
5.2	An example that shows the different verification results between the analysis technique C and R . C -the property holds. R -the property does not hold.	49

5.3	An example that shows the difference in verification results between the analysis technique C and R caused by resource deadlock. C -the property holds. R -the property does not hold.	49
5.4	Little-JIL diagram to illustrate how to use XPath expressions to navigate activities.	53
5.5	XML representation of an unrolled Little-JIL diagram in Figure 5.4. This XML document is used only for purposes of explaining XPath.	53
5.6	XPath expression examples that select activities in Figure 5.4.	54
5.7	Overview of static process- and resource-aware model checking approach. My approach translates resource specifications into the inputs of FLAVERS.	55
5.8	BIR template that handles a single resource allocation request. This example template assumes two resource objects that can handle Query without user specified resource utilization policies.	57
5.9	BIR template that handles a single resource release request that matches Figure 5.8.	59
5.10	BIR template that handles multiple allocation requests. This example template handles two allocation requests.	61
5.11	BIR template that handles multiple release requests. This example matches with Figure 5.10.	62
5.12	BIR template that handles multiple permission constraint policies. This example template encodes two permission constraint policies that restrict the possible allocation of two resource objects for a given request.	64
5.13	This example BIR template encodes a priority conflict resolution policy. A set of permission constraint policies of PA and PB has higher priority than a set of permission constraint policies of PB.	65
5.14	This example template encodes a case conflict resolution policy. A conflict condition is defined when a permission constraint policy PA is satisfied, but PB is not satisfied. This specific conflict case is resolved by enforcing only PB.	67
5.15	BIR to TFG translation: resource allocation BIR template in Figure 5.8.	68

5.16	BIR to TFG translation: resource release BIR template in Figure 5.9.	69
5.17	Constraint FSM associated with the integer range variable (<code>ResourceVar:</code> range 0..1) to reference two resource objects.	70
5.18	Constraint FSM that excludes infeasible traces of handling multiple requests from an activity.	71
5.19	Template constraint FSM that excludes infeasible resource utilization traces that violate resource capacity constraints.....	72
5.20	This property FSM encodes the same staff (e.g., MD and RN) property. The <code>idle</code> and <code>care</code> states are accepting states. The <code>violation</code> state is a trap state.	73
5.21	An example of resource event binding for the same MD property assuming three MD resource objects (<code>md0</code> , <code>md1</code> , and <code>md2</code>). The event names are declared in Figure 5.20	75
5.22	Overall ED process structure of Little-JIL and XPath expressions.	76
5.23	A node-tuple graph example: each vertex is associated with a unique state combination in a property FSM, a set of constraint FSMs, and a TFG node. Edges represent feasible state transitions.	77
6.1	Partial patient care process model by using Arena which incorporates six MDs working in three separate 8-hour shifts. (a) The shift and same doctor policies are included. (b) The shift, same doctor, and handoff policies are included.	81
6.2	MD and RN staffing demands curves using the staffing demands algorithm in Figure 4.5. For example, (a) is MD and RN staffing demands curves when MD's and RN's lower and upper utilization limits are set as 50% and 60%, respectively. I omitted other combinations of resource utilization ranges for exposition.	85
6.3	Simulation results of patient's LoS, contribution margin according to each utilization boundary. LoS <code>Requirements</code> is the LoS objective,so that four staffing, MD(50-60) RN(70-80), MD(60-70) RN(70-80), MD(70-80) RN(50-60) and MD(70-80) RN(60-70) satisfy it.	86

6.4	ILP solutions of various RN staffing patterns: (a) and (C) 12-hour shifts disallowing and allowing shift overlap, respectively; (b) 8-hour shift disallowing shift overlap; and (d) allowing for combinations of overlapping 6-, 8-, and 12-hour shifts. Staff salaries (USD/day): (a) 27,720, (b) 24,640, (c) 27,060 and (d) 21,560. I omitted other combinations such as 6-hour shifts allowing and disallowing shift overlap for exposition.	87
6.5	LoS comparison among various staffing	88
6.6	Number of handoffs comparison among various staffing	88
6.7	Utilization comparison among various staffing	89
6.8	Patient's LoS and contribution margin comparison: RN(BMC) RN staffing of Baystate Medical Center, RN(50–60) RN staffing derived by utilization limits 50%–60%, RN(60–70) RN staffing derived by utilization limits 60%–70%, and RN(70–80) RN staffing derived by utilization limits 70%–80%	90
6.9	Utilization comparison: RN(BMC) RN staffing of Baystate Medical Center, RN(50–60) RN staffing derived by utilization limits 50%–60%, RN(60–70) RN staffing derived by utilization limits 60%–70%, and RN(70–80) RN staffing derived by utilization limits 70%–80%	91
6.10	Utilization comparison over 24 hours a day: RN Utilization(BMC) RN utilization of Baystate Medical Center, RN Utilization(70-80) RN utilization derived by utilization limits 70%–80%	92
6.11	This property FSM encodes the shift property assuming there are three discrete time events: time 0, time 8, and time 16.....	93
6.12	Timer process that generates three discrete time events: time 0, time 8, and time 16.....	93
6.13	An example of resource event binding for the shift property assuming three MD resource objects (md0, md1, and md2). The event names are declared in Figure 6.11.	94
6.14	Doctor's capacity property FSMs. (a) A doctor can be reserved for three patients at most. (b) A doctor can care for one patient at the same time.	94
6.15	An example of resource event binding for the capacity property of an resource object (md0). The event names are declared in Figure 6.14.....	95

6.16	A counterexample violates that a <code>request_assign</code> event must be followed by an associated <code>assign</code> event.	96
6.17	This same staff property represents a medical provider can care for a patient only during the medical provider's shift hours.	97
6.18	An example of resource event binding for the same staff property in Figure 6.17.	97
6.19	A resource deadlock trace in the critical patient care process in my ED model.	98
6.20	Two process specification having a resource deadlock problem and not having the problem.	98
6.21	This property FSM represents a patient care process must be completed once started. <code>started</code> event is bound to the <code>started</code> event of the root activity of my ED activity model. <code>completed</code> event is bound to the <code>completed</code> event of the root activity of my ED activity model.	100
6.22	Comparison of how many patients can be included in analysis settings which vary the combination of policies.	100
6.23	Comparison of the sizes of analysis problems associated with verifications with all processes in Figure 6.22.	101
6.24	Comparison of the sizes of analysis problems by only changing property FSMs.	101
6.25	Comparison of how many patients can be included in analysis settings which vary capacity constraint FSMs and policies.	102
6.26	Comparison of the sizes of analysis problems by changing only handoff policy.	102
6.27	Verification results by changing the number of doctor resource objects. (a) compares the number of TFG nodes. (b) compares the elapsed verification times.	103
6.28	Comparison of the sizes of analysis problems by changing the combinations of including different resource types.	103

CHAPTER 1

INTRODUCTION

Human-intensive systems, where human, software, and hardware resources must be synergistically integrated to perform key functions, play an important role in our society. Because access to these resources is usually limited both by their small quantity and by restrictions on their availability, contention for them is often a serious problem. The problem is addressed by creating policies that are driven by system goals, regulations, or the need to satisfy the interests of different stakeholders. Resource utilization policies usually significantly impact system behaviors and results. Resource utilization policies range from simple, e.g., sickest patient first, to extremely complex, responding to changes in system's environment, state, and stimuli. Thus, for example, a hospital's staffing policy influences staff workload, costs, quality of patient care, etc. Therefore, resource utilization policies should be thoroughly evaluated and rigorously analyzed.

In addition to the inherent complexity of some policies, an additional major challenge in analyzing resource utilization policies is that policies can conflict with each other. This conflict may postpone system execution, or may even cause significant damage to the system such as creating a life-threatening situation in a hospital. Ideally, such conflicts should be anticipated so that if they arise, smooth operation of the system can nevertheless continue. However, as system size and complexity grow, policies tend to grow as well, both in number and in complexity. This increases the likelihood of conflicts and the difficulty of anticipating and resolving all of them. Therefore, evaluation and analysis of resource utilization policies have become even more challenging.

1.1 Motivating Example

Even though my research is designed to be generally applicable for human-intensive systems, this work focuses on a specific healthcare domain for exposition and evaluation - patient care processes in a hospital emergency department (ED). The patient care system integrates various kinds of resources and their utilization policies. Aspects of the system relevant for critical care require careful analysis of resource utilization policies before executing the policies in a real-world setting. In the worst case, inadequate analysis of resource utilization policies may result in life-threatening situations in a hospital ED.

Assuring sound management of the diverse kinds of human and other resources in a hospital ED is complex and made more so by the need for policies that must be sufficiently flexible to deal with many different kinds of circumstances. Thus, for example, nurses may perform technicians' activities such as Electrocardiogram (EKG) testing in crowded situations to alleviate the heavy workload on technicians, whereas these activities are performed only by technicians under normal circumstances. In addition, hospital staff can care for patients only during their shift hours. However, their shift hours may be changed if the hospital decides to make scheduling policy changes, for example to prepare for an increased incidence of accidents during a vacation season. Therefore, these dynamic changes in resources' system participation must be carefully considered to assure efficient and effective resource management.

In addition, the participation in patient care by hospital staff is restricted by various resource utilization policies that often conflict with each other. For instance, a patient in a hospital ED should be cared for by the same doctor and nurse while the patient stays in the ED. Under unusual circumstances, however, a hospital may allow violation of this policy to improve efficiency in patient care. For instance, if a highly-skilled nurse is too busy to care for his non-severe patients, he may be allowed to delegate his work (e.g., monitoring or discharge) to another nurse even though this delegation policy conflicts with the same nurse policy. Similarly, policies that define the work hours of shifts may also lead to conflicts with

the same doctor policy, for example when a patient is unable to be discharged until after the end of the shift of the admitting doctor. To address this policy conflict, hospitals necessarily incorporate a handoff policy requiring that a departing doctor hands over her patients to an incoming doctor. This handoff policy becomes even more complex when taking into account a doctor's workload, length of patient stay (LOS), and other patient care quality measurements.

Suboptimal policies for resolving hospital resource management conflicts can result in such problems as overcrowding, inefficient staff utilization, very long LOS, and other medical or financial problems. To address these problems, hospitals are always seeking better resource utilization policies. I believe my approach supports such efforts by facilitating (1) the exploration of various changes in resource utilization policies through the concentration of resource utilization policy issues into a separate component containing all resource allocation and conflict resolution specifications, (2) the use of discrete-event simulation to evaluate the effects of diverse alternative resource utilization policies, and (3) the verification of the adherence of these simulations to specified resource utilization and conflict resolution policies.

1.2 Contributions

My research provides a framework consisting of resource utilization policy specification and analysis for human-intensive systems. This framework extends an iterative process improvement framework [4, 10, 51] by focusing on resource utilization improvement. The specification approach describes resources and their interactions in a system formally according to separated resource concerns such as resource characteristics, resource request and resource utilization policy concerns. My approach separates resource utilization policy concerns from other resource characteristics and resource request concerns. My approach provides three types of policy specifications: permission constraint policies to restrict the capability support of a resource, conflict resolution policies to resolve a conflict between

multiple resource utilization policies, and scheduling policies to define precedence among requests or resources. For analysis, my research develops a process- and resource-aware discrete-event simulator that adheres to the resource utilization policy specification to support dynamic analysis of the effects of diverse resource utilization policies. In addition, my approach provides a process- and resource-aware model checking technique that supports static analysis of resource utilization policies in a system. For example, my static resource analyzer guarantees the absence of violations of resource utilization policies as well as other general resource utilization properties related to resource capacity, deadlock and leak.

My research makes the following main contributions:

- Precise specification language for resources and resource utilization policies (permission constraints, conflict resolutions, and schedules)
- Process- and resource-aware discrete-event simulations that adhere to the resource utilization policy specifications
- Process- and resource-aware model checking that verifies system properties and adherence to resource utilization policies
- Elaborated patient care process models based on real-world data and the domain expert's knowledge
- A case study applying my approach to validate and verify patient care processes in a hospital ED

CHAPTER 2

RESOURCE MANAGEMENT ISSUES

This chapter describes challenges in making efficient and effective resource management decisions. I categorize the issues into the three concerns: resource characterization, resource request specification, and resource utilization policy definition.

2.1 Resource Characteristics

Characterizing resources is an essential basis for resource management. In previous work [59], I showed that resources can be considered to be objects that are instances of well-defined types. In this dissertation, I have extended the facilities for resource definition in ways that are detailed in the following section of this dissertation, responding to new challenges in addressing ED process details. As noted in [51], I identify the following issues in defining resource types:

- **Resource diversity:** The range of resources to define is unusually broad, encompassing all kinds of hardware, software, and human resources. For instance, the resources in a hospital system include doctors, porters, EHRs, CT scanners, beds, and blood. I treat all as objects of types having internal state, and defined in terms of their abstract interfaces. Thus I define categories of resources such as doctors and infusion pumps to be types, characterized primarily by the capabilities that they offer and their attribute sets. Individual doctors and infusion pumps are defined as objects of these types, differentiated from each other primarily by the values of their attributes.
- **Resource attributes:** Resource attributes are used to characterize objects sufficiently well to support intelligent decision-making about their suitability for satisfying re-

quests. Thus all resources have a Capacity attribute. Human resources typically have such attributes as name, age, title, and education. Hardware resource attributes can include model number, serial number, date purchased, and power requirements. Software resource attributes often include programming language, operating system requirements, size, and speed.

- **Resource capabilities:** The abstract interface to a resource consists primarily of a set of capabilities, each of which corresponds to a specification of a kind of task that this resource can be counted upon to be able to perform. Thus, for example, a nurse resource should have the *inject medication* capability, and an Electronic Healthcare Record (EHR) should have the *get most recent Electrocardiogram* capability.
- **Dynamic characteristics:** In the work described in this dissertation, I addressed the new challenge of recognizing that resource characteristics and capabilities change dynamically over time and with changes in system environment. Thus, while [51] addressed the need for the values of a resource's attributes (e.g., location, availability, and even skill levels) to change over time, in this new work I address the need for the set of capabilities offered by a resource to also change over time for various reasons such as breaks, lunches, power outages, network unavailability, and cool-down periods.

2.2 Resource Requests

Characterizing the need for a resource is no less essential to effective resource management. Again, earlier work [59] characterized a need for a resource as an object, defined principally as a set of attributes. The principal attribute is the type of capability being requested. But in the work described in this dissertation I have added rigor in the specification of some additional attributes. Thus, for example, I have added the *purpose* attribute, to support reservation of resources. I observe that hospital resources such as beds, doctors, and nurses may sometimes need to be reserved in advance to minimize delay in providing care

for an incoming patient. Such resources are expected then to be allocated only when the patient actually arrives, but might also be preempted to meet a greater need, as determined by some defined policy (to be discussed shortly). The *purpose* attribute supports differentiation between reservation and allocation.

Other attributes are intended to provide help in handling resource contention, a central problem in resource management. Because operating efficiency demands that systems not be resourced too generously, there will be simultaneous requests for identical or similar capabilities. In some cases an exact resource instance (e.g. the same doctor who performed the most recent procedure) is required, but in other cases substitutions are acceptable. When a requested resource is not immediately available, there are circumstances under which the requestor is willing to wait, and some where waiting is intolerable. Accordingly, a resource request object can specify whether substitutions are acceptable or not, and whether the request is a blocking request or not. Other such attribute specifications are incorporated into my request language.

2.3 Resource Utilization Policies

The matching of resource requests to resource specifications is typically governed by policies that may be diverse, complex, and even inconsistent with each other. Policy diversity results from the need to address the desires and constraints of many different stakeholders. Attempting to meet all of these needs in turn leads to policies each of which can be intricate, complex, and varying over time. The growth in the number of such policies then leads to the possibility that some will come into conflict with each other, perhaps only under some circumstances, and at different times.

For instance, a hospital ED allows the use of hallway beds only when the ED is crowded, most of its main beds are occupied, and the patients waiting for bed placement are not severely ill. This policy references different characterizations of the system environment (level of ED crowding, level of main ED bed utilization, acuity level of patients awaiting

admission, etc.), but any of these characterizations might change with changing circumstance. Thus, for example, in an emergency situation, a different level of acuity might be used to determine the suitability of a waiting patient for admission to a hallway bed.

Ultimately, the principal goal of all of these notations is to support defining policies whose application resolves resource contention problems. Policies that resolve resource contention problems greatly affect the behavior of systems, and the more critical the system, the more vital it is to have effective resource contention policies. Such policies can resolve problems in variety of ways, for example by prioritizing and sequencing competing resource requests, or by identifying alternatives to requested resources, For instance, a policy might specify that a nurse can be allowed to perform a doctor's task such as prescribing medication, but only under stringently restricted circumstances. Or the policy might instead mandate that the prescribing task must simply wait for the availability of a doctor. That policy, on the other hand, might cause the violation of other policies, however, such as a policy that might limit the amount of time that the prescribing task can be allowed to wait. In case of such policy conflicts it is important that the resolution of such conflicts also be precisely defined.

Thus it is easy to see that it can be difficult to define policies precisely and completely, but that precision and completeness are essential in order to support the need both to be sure that policies are enforced correctly, and also to detect the possibility of policy conflicts, and the satisfactory resolution of such conflicts. The next chapter of this dissertation describes my approach to supporting such specifications.

CHAPTER 3

RESOURCE MODELING

This chapter describes my specification approach which describes resources and resource utilization policies in human-intensive systems. My specification approach has been inspired by the resource specification approach developed by Raunak [50]. Raunak provides a resource specification method according to resource requests and characteristics. However, his approach has limitations in specifying complex resource utilization policies. To be specific, specifying a constraint policy is difficult if the constraint policy is related to multiple resources, requests and other contexts. In addition, he does not support any cases of conflict resolutions.

Resource utilization policies influence the utilization of resources in systems and are derived from business goals, regulations, or other agreements among stakeholders. For example, in hospitals, staff members are available to participate in patient care only during their shift hours. A shift scheduling policy is designed to meet a variety of needs such as maximizing profits, providing high quality patient care, accommodating preferences of staff members' working hours, adhering to labor regulations, and so on. Resource utilization policies are often related to a system's aspects such as time, resources, activities and artifacts. To improve the specification and analysis capabilities of resource utilization policies, my specification approach to resources and resource utilization policies is orthogonal to, and separate from, other specifications such as activity and data flow specifications. I provide a set of resource specifications consisting of resource characteristics, requests and utilization policies.

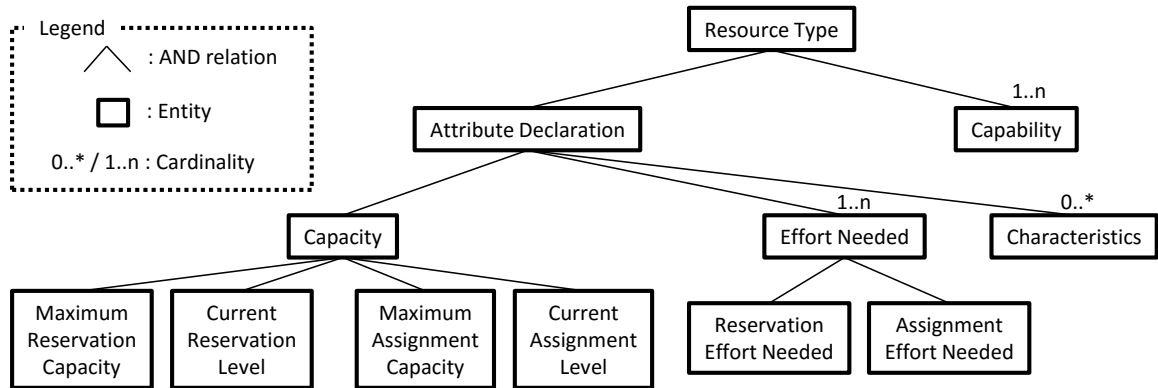

Figure 3.1. The structure of resource characteristics describes the static relations of the entities that define a resource type. Cardinality $1..n$ denotes one or n numbers. Cardinality $0..*$ represents zero or more.

To describe the rest of this chapter - resource characteristics, resource requests, and resource utilization policies - I use some basic notations. Let P be a process of interest. Let \mathbf{A}_P represents the set of all different activities of process P . An activity $A \in \mathbf{A}_P$ is an atomic activity that requires a set of resource objects to be performed. Let \mathbf{S}_P be the set of all possible system states of process P . A specific system state $S \in \mathbf{S}_P$ is characterized by the information of time, activities' execution states (e.g., see the states of steps in [72]), and artifact (or data) values associated with each activity. I assume that each state is discretized by time. States related to resources are not included in $S \in \mathbf{S}_P$ which are defined in the remaining sections.

3.1 Resource Characteristics

Resource characteristics are separately specified from other resource concerns such as requests and resource utilization policies. Figure 3.1 describes the structure of resource characteristics. As can be seen in Figure 3.1, a resource type is modeled as the composition of a set of attribute declarations and a set of capabilities. Attribute declarations of a resource type describe the common nature across resource objects of the same type, and its capability set is the set of services that a resource object of the type can provide to perform activities.

Definition 1 and Definition 2 show the rigorous definitions of an attribute declaration and a capability, respectively.

Definition 1 (Attribute declaration). *An attribute declaration, AD , is a 2-tuple $(ID_{AD}, \mathbf{V}_{AD})$, where*

- ID_{AD} is the string identifier representing the attribute name of AD .
- \mathbf{V}_{AD} is the set of elements that represents the attribute values of AD .

Attributes such as the resource's age, experience, job title, and skill are used in characterizing individual resource objects. Then, an attribute declaration defines the name of an attribute and the possible values of the attribute. A resource type includes a set of attribute declarations. Given Definition 1, let \mathbf{AD}_P be the set of all attribute declarations of all resource types used in process P .

Definition 2 (Capability). *A capability, C , is a service that a resource object is able to provide in performing an activity $A \in \mathbf{A}_P$.*

A resource type also includes a set of capabilities - the services that a resource object of the type is able to provide in performing activities. For instance, suppose P is a patient care process in a hospital ED. Then, \mathbf{A}_P includes activities to care for patients. Capabilities needed to support the patient care activities might include prescribing medications, ordering tests, assigning bed-placement priorities, and other capabilities of hospital resources. Given Definition 2, let \mathbf{C}_A be the set of elements representing resource capabilities required by activity $A \in \mathbf{A}_P$ to be performed. Then, let \mathbf{C}_P be the set of all capabilities required by all activities in \mathbf{A}_P such that $\mathbf{C}_P = \bigcup_{A \in \mathbf{A}_P} \mathbf{C}_A$.

Other particularly important attributes are the capacity attributes used to determine the ability to take on new allocations of a resource object. As can be seen in Figure 3.1, each resource type includes four capacity attribute declarations such as Maximum Reservation Capacity, Current Reservation Level, Maximum Assignment Capacity, and Current

Assignment level. I define the capacity attribute declarations in Definition 3 where \mathbb{N} refers to the set of all natural numbers.

Definition 3 (Capacity attribute declaration). \mathbf{AD}_P has four distinguished elements: (CP_{MR}, \mathbb{N}) , (CP_{CR}, \mathbb{N}) , (CP_{MA}, \mathbb{N}) , and (CP_{CA}, \mathbb{N}) , where

- (CP_{MR}, \mathbb{N}) is the attribute declaration of maximum reservation capacity.
- (CP_{CR}, \mathbb{N}) is the attribute declaration of current reservation level.
- (CP_{MA}, \mathbb{N}) is the attribute declaration of maximum assignment capacity.
- (CP_{CA}, \mathbb{N}) is the attribute declaration of current assignment level.

A resource object then has four distinguished capacity attributes according to the capacity attribute declarations in Definition 3. The maximum reservation capacity of a resource object quantifies the maximum amount of effort that the resource object can provide to handle reservation requests at any given time. The resource manager will not reserve an additional activity to the resource object if it determines that the sum of the current reservation level and the reservation effort-needed required by the new activity will exceed the resource object's maximum reservation capacity. The reservation effort-needed for a capability support defines the amount of effort that a resource object must reserve in order to be able to provide the capability at some future time. Similarly, the attributes of maximum assignment capacity, current assignment level, and assignment effort-needed of a resource object are used for assignment requests. I define the effort-needed attribute declarations in Definition 4.

Definition 4 (Effort-needed attribute declaration). \mathbf{AD}_P has $2 \times |\mathbf{C}_P|$ distinguished elements: $(EF_{RE,C}, \mathbb{N})$ and $(EF_{AE,C}, \mathbb{N})$ for all $C \in \mathbf{C}_P$, where

- $(EF_{RE,C}, \mathbb{N})$ is an attribute declaration of reservation effort-needed for C .
- $(EF_{AE,C}, \mathbb{N})$ is an attribute declaration of assignment effort-needed for C .

Given the above definitions, I define a resource type in Definition 5 that classifies a set of resource objects sharing the resource characteristics of attributes and capabilities.

Resource type : MD		
Attribute declarations	Characteristics	$(name, String), (shiftStart, Time), (shiftEnd, Time)$
	Capacity	$(CP_{MR}, \mathbb{N}), (CP_{CR}, \mathbb{N}), (CP_{MA}, \mathbb{N}), (CP_{CA}, \mathbb{N})$
	Effort-needed	$(EF_{RE,MDTreat}, \mathbb{N}), (EF_{AE,MDTreat}, \mathbb{N})$
Capabilities	$\{MDTreat\}$	

Figure 3.2. An example of doctor resource type MD for the process of treating patients.

Definition 5 (Resource type). A resource type, T , associated with process P is a 2-tuple $(\mathbf{AD}_T, \mathbf{C}_T)$, where

- \mathbf{AD}_T is the set of all attribute declarations of T such that $\mathbf{AD}_T \subseteq \mathbf{AD}_P$.
 - $(CP_{MR}, \mathbb{N}), (CP_{CR}, \mathbb{N}), (CP_{MA}, \mathbb{N}), (CP_{CA}, \mathbb{N}) \in \mathbf{AD}_T$.
- \mathbf{C}_T is the set of all capabilities provided by T such that $\mathbf{C}_T \subseteq \mathbf{C}_P$.
 - for each $C \in \mathbf{C}_T$, $(EF_{RE,C}, \mathbb{N}), (EF_{AE,C}, \mathbb{N}) \in \mathbf{AD}_T$.

For instance, Figure 3.2 shows an example of doctor type MD . MD has $(name, String)$ attribute declaration to specify an MD doctor object's name. MD also has the work shift, specified by $(shiftStart, Time)$ and $(shiftEnd, Time)$ attribute declarations for specifying the only times when a resource object of the type can be allocated to an activity. MD provides $MDTreat$ capability to care for patients. As can be seen in Definition 5, MD includes the capacity attribute declarations and effort-needed attribute declarations for $MDTreat$ capability. Given Definition 5, let \mathbf{T}_P be the set of all resource types associated with P such that for all $T \in \mathbf{T}_P$, $\mathbf{AD}_T \subseteq \mathbf{AD}_P$ and $\mathbf{C}_T \subseteq \mathbf{C}_P$. Then, Definition 6 and Definition 7 define a resource object and its state, respectively.

Definition 6 (Resource object). A resource object of type $T \in \mathbf{T}_P$, R_T , is a 2-tuple $(\mathbf{AF}_{R_T}, \mathbf{C}_{R_T})$, where

- \mathbf{AF}_{R_T} is the set of functions associated with \mathbf{AD}_T , $\{\mathcal{A}_{AD,R_T} \mid AD \in \mathbf{AD}_T\}$, whose domains and codomains are specified in the following:

<i>MD</i> resource object	Attribute values
<i>md0</i>	$name = DA, shiftStart = 00 : 00, shiftEnd = 08 : 00$ $CP_{MR} = 4, CP_{CR} = 2, CP_{MA} = 1, CP_{CA} = 0$ $EF_{RE,MDTreat} = 1, EF_{AE,MDTreat} = 1$
<i>md1</i>	$name = DB, shiftStart = 00 : 00, shiftEnd = 08 : 00$ $CP_{MR} = 4, CP_{CR} = 4, CP_{MA} = 1, CP_{CA} = 1$ $EF_{RE,MDTreat} = 1, EF_{AE,MDTreat} = 1$
<i>md2</i>	$name = DC, shiftStart = 08 : 00, shiftEnd = 16 : 00$ $CP_{MR} = 4, CP_{CR} = 0, CP_{MA} = 1, CP_{CA} = 0$ $EF_{RE,MDTreat} = 1, EF_{AE,MDTreat} = 1$
<i>md3</i>	$name = DD, shiftStart = 08 : 00, shiftEnd = 16 : 00$ $CP_{MR} = 4, CP_{CR} = 0, CP_{MA} = 1, CP_{CA} = 0$ $EF_{RE,MDTreat} = 1, EF_{AE,MDTreat} = 1$
<i>md4</i>	$name = DE, shiftStart = 16 : 00, shiftEnd = 24 : 00$ $CP_{MR} = 4, CP_{CR} = 0, CP_{MA} = 1, CP_{CA} = 0$ $EF_{RE,MDTreat} = 1, EF_{AE,MDTreat} = 1$
<i>md5</i>	$name = DF, shiftStart = 16 : 00, shiftEnd = 24 : 00$ $CP_{MR} = 4, CP_{CR} = 0, CP_{MA} = 1, CP_{CA} = 0$ $EF_{RE,MDTreat} = 1, EF_{AE,MDTreat} = 1$

Figure 3.3. Example states of six resource objects of *MD* type working during different shifts at a system state of a patient care process in a hospital ED.

- \mathcal{A}_{AD,R_T} is an attribute function, $\mathcal{A}_{AD,R_T} : \mathbf{S}_P \rightarrow \mathbf{V}_{AD}$,

- \mathbf{C}_{R_T} is the set of all capabilities provided by R_T such that $\mathbf{C}_{R_T} = \mathbf{C}_T$.

Given Definition 6, let \mathbf{R}_T be the set of resource objects of T type. Then, let \mathbf{R}_P be the set of all resource objects used in process P such that $\mathbf{R}_P = \bigcup_{T \in \mathbf{T}_P} \mathbf{R}_T$.

Definition 7 (Resource state). $\mathcal{AS}(R,S)$ is the state of resource object $R \in \mathbf{R}_P$ at state $S \in \mathbf{S}_P$, where

- $\mathcal{AS}(R,S) = \{(\mathcal{A}, \mathcal{A}(S)) \mid \mathcal{A} \in \mathbf{AF}_R\}$.

Figure 3.3 shows the states of six resource objects of *MD* type at a system state $S \in \mathbf{S}_P$ assuming P refers to a patient care process in a hospital ED. The six doctors work in pairs

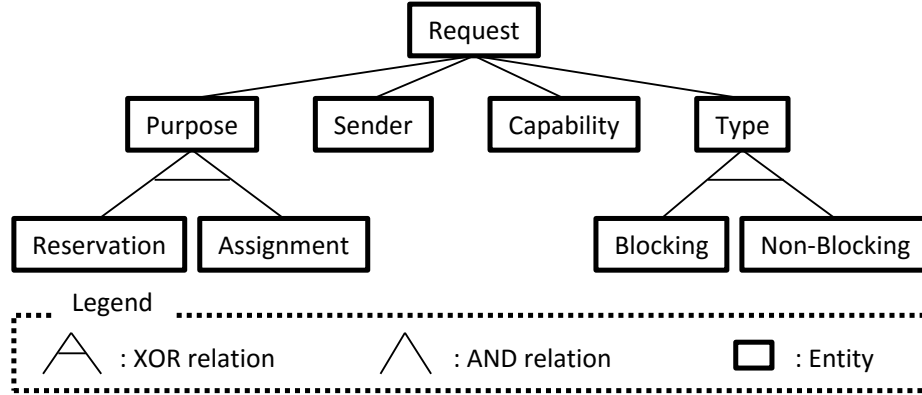

Figure 3.4. The structure of a resource request describes the static relations of the entities that define a resource request.

on three different shifts. $md0$ and $md1$ work from 00 : 00 to 08 : 00. $md2$ and $md3$ work from 08 : 00 to 16 : 00. $md4$ and $md5$ work from 16 : 00 to 24 : 00. Maximum reservation capacity $CP_{MR} = 4$ means that a doctor is allowed to be responsible for the treatment of up to four patients since $EF_{RE,MDTreat} = 1$. On the other hand, maximum assignment capacity $CP_{MA} = 1$ means that a doctor can be delivering service to only one patient at a time because $EF_{AE,MDTreat} = 1$. In this example, doctor $md0$ has been reserved to care for two patients (see $CP_{CR} = 2$) and the doctor is not actually caring for any patients at state S (see $CP_{CA} = 0$). However, doctor $md1$ has already been reserved to care for four patients, so $md1$ is not able to see new patients until she discharges her patients (i.e., released from her patients). At state S , $md1$ is actually caring for one patient (see $CP_{CA} = 1$).

3.2 Resource Requests

A resource model includes specifications of resource requests. Each activity in a system generates a separate request for each resource object it needs. My resource request specification restricts a valid set of resource objects which provide the capabilities necessary to perform activities. For example, in a hospital, performing an EKG or drawing blood is restricted to nurses or technicians who provide these required capabilities. However,

technicians are not allowed to assess patients. In addition, even though resource objects provide the same requested capability, candidate resource objects to perform activities are further restricted according to the request context such as request time and sender information. For example, day shift doctors are not considered as candidates to care for patients during night shifts.

Figure 3.4 shows the static relation of my resource request specification entities. A resource request is either a `Reservation` or an `Assignment` request based on the purpose of the request. Sender activity information is required to define a resource request to identify the context information such as what other resource objects are requested and which artifacts are used by the sender activity. Both reservation and assignment requests ask for a resource object that performs a particular `Capability`. Which resource object is returned depends on the dynamic state of the process. For example, a doctor may be assigned to draw a patient’s blood, but only when all nurses are fully assigned, and only when the blood draw task is considered to require a small amount of effort and a low skill level. My specification approach separates out these dynamic state concerns to specify resource utilization policies. Resource requests query a resource object through a capability. A `Non-Blocking` request from an activity requires immediate notification from a resource manager if the request is not able to be handled at that time. On the other hand, a `Blocking` request from an activity is a request that blocks the execution of the activity until the request is handled by a resource manager.

To define a resource request, I assume that each $A \in \mathbf{A}_P$ generates unique requests for exposition. Duplicated requests to allocate multiple resources can be easily distinguished by using unique request identifiers during the implementation phase. I define a resource request in Definition 8.

Definition 8 (Resource request). *A resource request, Q , is defined as a 4-tuple $(Q_{purpose}, Q_{sender}, Q_{capability}, Q_{type})$, where*

- $Q_{purpose}$ is a request purpose of Q , either reservation or assignment.

Purpose	Sender	Capability	Type
<i>reservation</i>	<i>Treat</i>	<i>MDTreat</i>	<i>blocking</i>
<i>reservation</i>	<i>Treat</i>	<i>RNTreat</i>	<i>blocking</i>
<i>assignment</i>	<i>Triage</i>	<i>Triage</i>	<i>blocking</i>
<i>assignment</i>	<i>Register</i>	<i>Register</i>	<i>blocking</i>
<i>assignment</i>	<i>PlaceInBed</i>	<i>PlaceInBed</i>	<i>blocking</i>
<i>assignment</i>	<i>RNAssess</i>	<i>RNTreat</i>	<i>blocking</i>
<i>assignment</i>	<i>MDAssess</i>	<i>MDTreat</i>	<i>blocking</i>

Figure 3.5. Examples of resource requests from patient care activities in a hospital ED.

- Q_{sender} is a request sender activity of Q such that $Q_{sender} \in \mathbf{A}_P$.
- $Q_{capability}$ is a requested capability of Q such that $Q_{capability} \in \mathbf{C}_A$, $A = Q_{sender}$.
- Q_{type} is a query type of Q , either *blocking* or *nonblocking*.

Given Definition 8, let \mathbf{Q}_A be the set of resource requests from activity $A \in \mathbf{A}_P$. Then, let \mathbf{Q}_P be the set of all possible requests that process P may generate such that $\mathbf{Q}_P = \bigcup_{A \in \mathbf{A}_P} \mathbf{Q}_A$.

Figure 3.5 shows some example specifications of resource requests from patient care activities in a hospital ED. For instance, when a new patient presents in an ED, *Treat* activity first reserves (*reservation*) a doctor who provides *MDTreat* capability to care for the patient. The request working as *blocking* means that the new patient must wait until a doctor has been reserved for the patient.

At some state $S \in \mathbf{S}_P$, let \mathbf{A}_S be the set of activities that are ready and waiting to get started. Then, let \mathbf{Q}_S be the set of resource requests from \mathbf{A}_S where they are not handled yet such that $\mathbf{Q}_S = \bigcup_{A \in \mathbf{A}_S} \mathbf{Q}_A$. Among the resource requests in \mathbf{Q}_S , a resource request $Q \in \mathbf{Q}_S$ might be handled by a resource object $R \in \mathbf{R}_P$ where $Q_{capability} \in \mathbf{C}_R$ through either reservation or assignment allocation based on query purpose $Q_{purpose}$. However, the information about resources and requests is not sufficient to model real-world resource allocation because there are too many possible allocations to specify resource utilization in

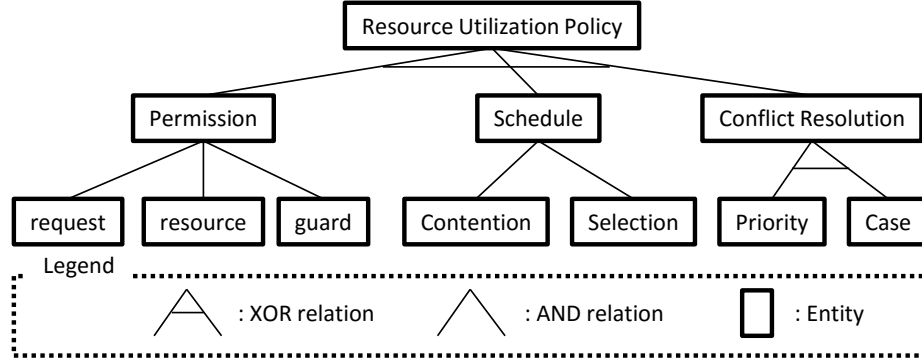

Figure 3.6. The structure of the resource utilization policy specification describes the static relations between the policy’s entities.

a real-world system. Feasible resource allocations are subject to capacity constraints and various resource utilization policies.

3.3 Resource Utilization Policies

Human-intensive systems incorporate diverse kinds of resource utilization policies. These resource utilization policies are related to many aspects in systems such as activities, artifacts, requests and resources. I separate resource utilization policy concerns from others such as resource characteristics and requests. Figure 3.6 shows that my specification approach provides facilities for the specification of three different kinds of resource utilization policies, namely permission constraint policies (*Permission*), scheduling policies (*Schedule*), and conflict resolution policies (*Conflict Resolution*).

3.3.1 Permission Constraint Policy

A *Permission* constraint policy specifies the permissibility of a *Resource* to handle a *Request* as restricted by a specified *Guard* condition. Definition 9 defines a permission constraint policy. I define a permission constraint policy in Definition 9.

Definition 9 (*Permission constraint policy*). A *permission constraint policy*, PC , is defined as a 3-tuple $(\mathbf{Q}_{PC}, \mathbf{R}_{PC}, G_{PC})$, where

Permission constraint policy	$(\mathbf{Q}_{PC}, \mathbf{R}_{PC}, \mathcal{G}_{PC})$
<i>SameMD</i>	$(\mathbf{Q}_{MDTreat}, \mathbf{R}_{MD}, \mathcal{G}_{SameMD})$
<i>ShiftMD</i>	$(\mathbf{Q}_{MDTreat}, \mathbf{R}_{MD}, \mathcal{G}_{ShiftMD})$

Figure 3.7. Examples of permission constraint policies in a patient care process in a hospital ED.

- \mathbf{Q}_{PC} is the set of all requests restricted by PC.
- \mathbf{R}_{PC} is the set of all resource objects restricted by PC.
- $\mathcal{G}_{PC} : \mathbf{S}_P \times \mathbf{Q}_{PC} \times \mathbf{R}_{PC} \rightarrow \{true, false\}$ is a function that defines the guard of PC. \mathcal{G}_{PC} is evaluated to be true only if $R \in \mathbf{R}_{PC}$ can handle $Q \in \mathbf{Q}_{PC}$ at $S \in \mathbf{S}_P$. Otherwise, $G(PC)$ is evaluated to be false.

Given Definition 9, let \mathbf{PC}_P be the set of all permission constraint policies restricting the utilization of all resource objects in process P . Satisfaction of a permission constraint policy $PC \in \mathbf{PC}_P$ is determined by the guard of PC . For example, the *SameMD* and *ShiftMD* permission constraint policies can be specified as shown in Figure 3.7. $\mathbf{Q}_{MDTreat}$ refers to the set of resource requests requiring *MDTreat* capability in a patient care process of a hospital ED. Thus, $\mathbf{Q}_C = \{Q \mid Q \in \mathbf{Q}_P; Q_{capability} = C\}$. The *SameMD* permission constraint policy is used to determine which *MD* resource object in \mathbf{R}_{MD} is available to handle a request requiring the *MDTreat* capability in $\mathbf{Q}_{MDTreat}$. Similarly, the *ShiftMD* permission constraint policy is used to define the *MD* resource object's shift, namely the hours during which an *MD* resource object in \mathbf{R}_{MD} is allowed to handle a request in $\mathbf{Q}_{MDTreat}$. A guard function is represented as a boolean expression that is evaluated to be true only when a resource object can handle a request. For instance, I specify $\mathcal{G}_{ShiftMD}$ as $t \geq r.shiftStart \ \&\& \ t < r.shiftEnd$ where r is one of the *MD* resource objects (\mathbf{R}_{MD}), *md0*, *md1*, *md2* or other resource objects in Figure 3.3. The Boolean expression is evaluated to be true only when an *MD* resource object r is working on her shift when a request for *MDTreat* capability happens at time t .

To handle a request $Q \in \mathbf{Q}_{PC}$, the set of permission constraint policies, $\mathbf{PC}_Q = \{PC \mid PC \in \mathbf{PC}_P; Q \in \mathbf{Q}_{PC}\}$, restricts the set of specific resource objects that satisfies all the guards of permission constraint policies. These resource objects are named as candidate resource objects. Let $\mathbf{CAN}_{S,Q,PC}$ be the set of resource objects which can handle a request $Q \in \mathbf{Q}_{PC}$ at a state $S \in \mathbf{S}_P$ while satisfying $PC \in \mathbf{PC}_Q$ such that $\mathbf{CAN}_{S,Q,PC} = \{R \mid R \in \mathbf{R}_{PC}; G_{PC}(S,Q,R) = true\}$. Then, let the set of candidate resource objects to handle a request Q at state S , $\mathbf{CAN}_{S,Q}$, be $\mathbf{CAN}_{S,Q} = \bigcap_{PC \in \mathbf{PC}_Q} \mathbf{CAN}_{S,Q,PC}$.

3.3.2 Scheduling Policy

The next policy specification approach, the `Schedule` policy, supports the specification of `Contention` and `Selection` policies. `Contention` policies specify precedence among requests. Specifically, I support specification of built-in policies such as random, first-in first-out (FIFO), last-in first-out (LIFO), and priority-based as well as custom-built policies that can be built based on the use of dynamic system state variables, such as patient load. In a hospital ED, for instance, when multiple patient care activities for different patients require the service of more doctors than are currently available for allocation, an appropriate scheduling policy is necessary to resolve the contention problem among the requests for the services of all doctor resources. I define a contention policy in Definition 10.

Definition 10 (Contention policy). *A contention policy, CT , is defined as 2-tuple $(\mathbf{Q}_{CT}, \mathcal{CF}_{CT})$, where*

- \mathbf{Q}_{CT} is the set of all resource requests scheduled by CT that may cause a contention problem among the requests.
- $\mathcal{CF}_{CT} : \mathbf{S}_P \times \mathcal{P}(\mathbf{Q}_{CT}) \rightarrow \mathbf{Q}_{CT}$ is a partial function defining a contention policy that selects a request to be handled at a state. \mathcal{CF}_{CT} is undefined for an empty set of requests at a state. $\mathcal{P}(\mathbf{Q}_{CT})$ refers to the power set of \mathbf{Q}_{CT} .

As can be seen in Figure 3.8, the sickest patient first policy is a contention policy that is often used in a hospital ED, specifying that a doctor cares for patients according to the

Contention policy: *SPF* (sickest patient first policy)
 ($\mathbf{Q}_{MDTreat}, \mathcal{CF}_{SPF}$)

Figure 3.8. An example of a contention policy in a hospital ED. This example includes only the key features specifications.

urgency of their need. \mathcal{CF}_{SPF} selects the urgent request from a set of requests for $MDTreat$ capability from multiple patient care activities according to associated patient record data such as the patient’s acuity level. The effects of the contention policy should be carefully evaluated, however, as enforcing it rigorously can result in the needs of very sick patients causing resource starvation of non-acutely ill patients who might then fail to receive timely treatment. Simulation studies should facilitate such evaluations. Given Definition 10, let \mathbf{CT}_P be the set of all contention policies scheduling all resource requests used in process P .

A Selection policy complements a Contention policy, supporting specification of precedence among the resource objects capable of handling a resource request. If there are many candidate resource objects able to handle a given request, an effective selection policy can lead to more efficient and effective utilization of those resources. For instance, when a new patient arrives in an ED, there are usually more than two doctors who can assess the patient. An appropriate workload policy can do much to balance the workloads of the different doctors. I provide built-in selection policies such as random, least recently used (LRU) and most recently used (MRU), as well as custom policies that can be defined based on the use of system dynamic state variables. Thus, for example, a least utilized resource first policy might be used to balance the workloads of hospital staff members. I define a selection policy in Definition 11.

Definition 11 (Selection policy). *A selection policy, SL , is defined as 3-tuple $(\mathbf{Q}_{SL}, \mathbf{R}_{SL}, \mathcal{SF}_{SL})$, where*

- \mathbf{Q}_{SL} is the set of all resource requests constrained by SL .
- \mathbf{R}_{SL} is the set of resource objects which can handle a request in \mathbf{Q}_{SL} .

Selection policy: LU , (least utilized first policy)
 $(\mathbf{Q}_{MDTreat}, \mathbf{R}_{MDTreat}, \mathcal{SF}_{LU})$

Figure 3.9. An example of a selection policy in a hospital ED. This example includes only the key features specifications.

- $\mathcal{SF}_{SL} : \mathbf{S}_P \times \mathbf{Q}_{SL} \times \mathcal{P}(\mathbf{Q}_{SL}) \rightarrow \mathbf{R}_{SL}$ is a partial function that selects a resource object at a system state to handle a request. \mathcal{SF}_{SL} is undefined for a selection from an empty set of resource requests at a system state. $\mathcal{P}(\mathbf{Q}_{SL})$ refers to the power set of \mathbf{Q}_{SL} .

A selection policy, $SL \in \mathbf{SL}_P$, selects a resource object $R \in \mathbf{R}_{SL}$ based on a system state $S \in \mathbf{S}_P$ and a resource request $Q \in \mathbf{Q}_{SL}$. Given Definition 11, let \mathbf{SL}_P be the set of all selection policies selecting resource objects for all resource requests used in process P .

Figure 3.9 shows the least utilization first policy. \mathcal{SF}_{LU} selects a resource object in $\mathbf{R}_{MDTreat}$ which provides $MDTreat$ capability to handle a resource request in $\mathbf{Q}_{MDTreat}$ based on utilization levels of the resource objects. The resource utilization level is calculated based on information about dynamic system state variables such as the system's execution duration and resource allocation periods.

While a set of candidate resource objects $\mathbf{CAN}_{S,Q}$ for a request $Q \in \mathbf{Q}_P$ at a state $S \in \mathbf{S}_P$ satisfies all the permission constraint policies related to Q , some resource objects may not be able to handle request Q at system state S because of their capacity constraints. Thus, let $\mathbf{AVL}_{S,Q}$ be the set of resource objects that are available to handle the request Q at the state S such that $\mathbf{AVL}_{S,Q} \subseteq \mathbf{CAN}_{S,Q}$. Then, the selection policy associated with Q selects a resource object from $\mathbf{AVL}_{S,Q}$. In Figure 3.3, for example, $md0$ and $md1$ resource objects are candidates to handle a request for $MDTreat$ capability. However, only $md0$ is available to handle the request because $md1$ will violate its capacity constraint (see $CP_{MA} = 1$ and $CP_{CA} = 1$) if it handles the request.

Given the above definitions, valid resource allocations are determined by the following iterative steps: (1) select a request $Q \in \mathbf{Q}_S$ by considering a contention policy $CT \in \mathbf{CT}_P$

related to the request Q , (2) determine the set of candidate resource objects $\mathbf{CAN}_{S,Q}$ restricted by the associated permission constraint policies, (3) select the set of available resource objects $\mathbf{AVL}_{S,Q}$ from $\mathbf{CAN}_{S,Q}$ considering the capacity constraints of the candidate resource objects, (4) select a resource object from the set of available resource objects $\mathbf{AVL}_{S,Q}$ by using the associated selection policy $SL \in \mathbf{SL}_P$. However, enforcing multiple permission constraint policies may create a conflict condition in which there are no candidate resource objects that can handle request Q at state S , $\mathbf{CAN}_{S,Q} = \emptyset$, satisfying all the permission constraint policies. I address the conflict condition through conflict resolution policies.

3.3.3 Conflict Resolution Policy

Conflict resolution policies specify how to deal with other policies that may come into conflict with each other. For the circumstances under which two or more policies cannot be enforced at the same time, I provide capabilities for specifying Conflict Resolution policies. I provide two kinds of conflict resolution policies: a Priority conflict resolution policy and a Case conflict resolution policy.

3.3.3.1 Priority Conflict Resolution

A Priority conflict resolution policy specifies precedence among multiple sets of permission constraint policies. A system first enforces a high priority set of permission constraint policies; however, if a conflict condition occurs while forcing the permission constraint policies, the system enforces a low priority set of permission constraint policies to continue system services. Definition 12 defines this priority conflict resolution policy.

Definition 12 (Priority conflict resolution policy). *A priority conflict resolution policy, PR , is defined as 2-tuple $(\mathbf{Q}_{PR}, PR_{priority})$, where*

- \mathbf{Q}_{PR} is the set of all resource requests restricted by PR .

Priority conflict resolution policy: *HandoffMD*
 $(\mathbf{Q}_{MDTreat}, (\{\mathit{ShiftMD}, \mathit{SameMD}\}, \{\mathit{ShiftMD}\}))$

Figure 3.10. An example of priority conflict resolution policy in a hospital ED. This example include only the key features specifications.

- $PR_{priority} = (\mathbf{PC}_{PR,1}, \mathbf{PC}_{PR,2}, \dots, \mathbf{PC}_{PR,n_{PR}})$. $\mathbf{PC}_{PR,i}$ is an i_{th} set of permission constraint policies of PR . $\mathbf{PC}_{PR,i}$ has higher priority than $\mathbf{PC}_{PR,j}$ if $i < j$. n_{PR} is the number of sets of permission constraint policies of PR .

For instance, in a hospital ED, how doctors hand off patients at the end of their shifts can be defined using the priority conflict resolution policy in Figure 3.10. This conflict resolution policy, $(\mathbf{Q}_{MDTreat}, (\{\mathit{ShiftMD}, \mathit{SameMD}\}, \{\mathit{ShiftMD}\}))$, specifies that enforcing both the *ShiftMD* and *SameMD* permission constraint policies has higher priority than enforcing only the *ShiftMD* permission constraint policy. In other words, this states that the need to satisfy both *ShiftMD* and *SameMD* is considered first in allocating resource objects. However, if no resource objects are able to satisfy all the permission constraint policies, the permission constraint policy *ShiftMD* is applied next in considering possible resource allocations. In Figure 3.3, for instance, if *md0* ends her shift at 8PM, then *md0* is not able to care for her patients after 8PM because doing so would violate the *ShiftMD* policy. According to the above priority specification, however, another doctor, either *md2* or *md3*, is then permitted to provide care for the patients of *md0*, assuming these other doctors are on shift in the ED (i.e. assigning them must still satisfy the *ShiftMD* permission constraint policy). After resolving such a conflict condition, the system returns to full enforcement of all policies for subsequent resource allocation requests. Thus, for example, either *md2* or *md3* (whoever has taken the handoff) is obliged to satisfy the same doctor policy until her shift ends. Given Definition 12, let \mathbf{PR}_P be the set of all priority conflict resolution policies enforced in process P .

This kind of conflict resolution specification offers broad applicability. I note, for example, that the use of more highly skilled medical providers is generally preferred because it typically results in the provision of higher quality patient care. But less skilled providers may be allocated to certain tasks instead in order to improve the overall efficiency of the healthcare system in providing patient care in various kinds of complex situations. Moreover, as described in Section 1.1, in a particularly overcrowded ED, nurses may perform technician tasks such as taking EKGs. Conversely, even though nurses may be the preferred providers of certain kinds of patient care, a technician-use policy might dictate that technicians be allowed to provide these specified kinds of care to certain classes of patients when nurses are not available, perhaps due to nurse workload limitation policies. Similarly, the above priority policy allows the delegation of a doctor's work to another doctor when the first doctor's shift ends.

3.3.3.2 Case Conflict Resolution

In addition to a `Priority` conflict resolution policy, I provide another form of specification for conflict resolution, namely a `Case` conflict resolution policy. While a priority conflict resolution policy seems more suitable for specifying relatively straightforward conflict resolution, a case conflict resolution policy seems more suitable for complex conflict resolution situations. A case conflict resolution policy resolves a specific case of a conflict situation by a resolution action. Definition 13 defines a case conflict resolution policy.

Definition 13 (Case conflict resolution policy). *A case conflict resolution policy, CR , is defined as 2-tuple $(\mathbf{Q}_{CR}, CR_{conflict}, \mathbf{PC}_{CR,resolution})$, where*

- \mathbf{Q}_{CR} is the set of resource requests restricted by CR .
- $CR_{conflict} = (\mathbf{PC}_{CR,true}, \mathbf{PC}_{CR,false})$ describes a specific conflict case.
 - $\mathbf{PC}_{CR,true}$ is the set of permission constraint policies that are satisfied when a conflict occurs.

Case conflict resolution policy: *FTB* (fast-track bed utilization)
 $(\mathbf{Q}_{PlaceInFastBed}, (\{EmptyBed\}, \{InFastTrack, FastTrackOpen\}), \{EmptyBed\})$

Figure 3.11. An example of a case conflict resolution policy in a hospital ED. This example includes only the key features specifications.

- $\mathbf{PC}_{CR,false}$ is the set of permission constraint policies that are not satisfied when a conflict occurs.
- $\mathbf{PC}_{CR,resolution}$ is the set of permission constraint policies to resolve the specific conflict case, $CR_{conflict}$.

As an example, consider the *FTB* (fast-track bed utilization) policy in Figure 3.11. Many hospital EDs offer their patients care in two separate locations with separate facilities and use somewhat different processes. These are often referred to as the main-track (for seriously ill patients) and the fast-track (for all other patients). These are operated separately in order to improve their overall efficiency and quality in providing ED patient care. While the main-track operates 24 hours of every day, the fast-track is often closed during periods of slack demand, such as late at night, in order to save money. If the locations of the two tracks are not far from each other, hospitals often, especially during periods of heavy load, find it useful to utilize fast-track beds for both main-track and fast-track patients, even if the fast-track is closed. This policy can be defined clearly and concisely using the case conflict resolution policy, *FTB*. I do this by building upon some permission constraint policies and combining them using the case conflict resolution policy specification approach. Thus, I use the *EmptyBed* permission constraint policy, which enforces that a bed must not already be occupied in order for it to be used to care for a new patient. I use the *InFastTrack* permission constraint policy, which specifies that only fast-track patients are allowed to use beds in the fast-track. I use the *FastTrackOpen* permission constraint policy, which specifies the times during which the fast-track is open and closed. Given these three permission constraint policies, I can specify the typical use of a fast-track ED bed when it is allocated to

accept a new fast-track patient in an open fast-track to be: only when a bed is not occupied (*EmptyBed* satisfied), the bed and patient are located in the fast-track (*InFastTrack* satisfied), and the fast-track is open (*FastTrackOpen* satisfied).

But a case conflict resolution policy specification can, in addition, support the specification of the previously described conditions under which a fast-track bed can be allocated for main-track use even when the fast-track is closed. This conflict situation as described in Figure 3.11, is defined as $(\{EmptyBed\}, \{InFastTrack, FastTrackOpen\})$, which defines the situation in which a bed is not occupied, a patient is not located in the fast-track, and the fast-track is closed. It then specifies the conflict resolution as described by $\{EmptyBed\}$, which specifies that it is allowable to enforce only the *EmptyBed* policy to resolve the conflict situation (note that another schedule policy might be defined to enforce a preference for using a main-track bed over a fast-track bed, when both are available). Therefore, this conflict resolution policy specifies a flexible management of hospital bed resources by utilizing fast-track beds when the fast-track is closed. Given Definition 13, let \mathbf{CR}_P be the set of all case conflict resolution policies enforced in process P .

CHAPTER 4

DYNAMIC ANALYSIS THROUGH PROCESS- AND RESOURCE-AWARE DISCRETE-EVENT SIMULATION

This chapter describes a process- and resource-aware discrete-event simulator that dynamically analyze systems to evaluate diverse resource decisions that impact bottleneck, performance and other quality measures of the systems. Utilizing this framework, I am able to schedule resources to satisfy scheduling objectives and constraints.

4.1 Platform for Process- and Resource-Aware Discrete-Event Simulation

My approach relies on the existence of a precise, well-defined system process model. For the ED domain, this means a detailed model of the process by which patients are treated in an ED. I used the Little-JIL language [72] to specify this model. This section describes background information of Little-JIL which are relevant to my approach.

4.1.1 Little-JIL: Process Modeling

Little-JIL process definitions are based on the notion of functional decomposition of a high-level process into a hierarchy of activities. Little-JIL has well-defined semantics based on finite state machine (FSM) definitions, and is supported by a tool suite that includes a graphical editor that renders process definitions as visualizations (Figure 4.1 shows an example of such a visualization).

The central semantic element of a Little-JIL definition is the activity. Activities are connected by edges to parents (above) and children (below), with edges also specifying the

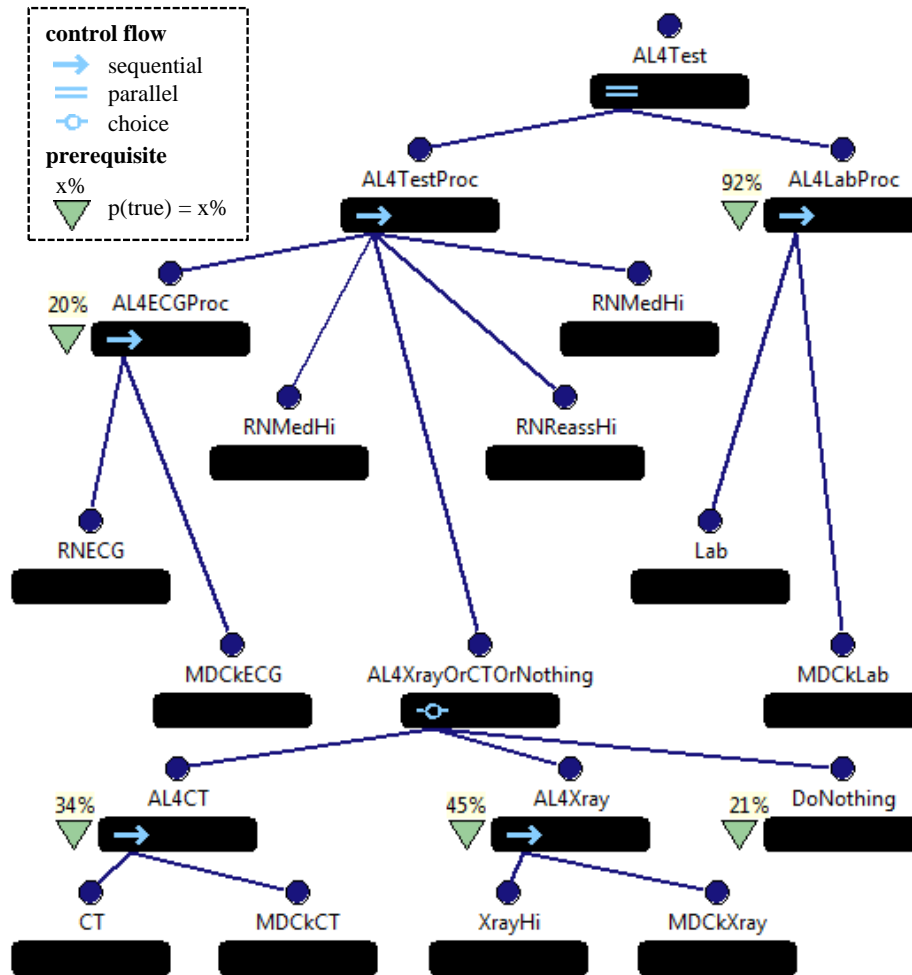

Figure 4.1. The Little-JIL definition of the patient testing process, which is part of the care an acuity-level-four patient undergoes in an ED

flow of arguments between parents and children. Parent activities both define scopes, and also specify the flow of control between children. The legend in Figure 4.1 indicates three different control flow possibilities: sequential (children performed in left-to-right order), parallel (children performed in any order, possibly concurrently), and choice (only one of the children selected for performance). Each activity also incorporates a specification of needed resources (e.g., doctor, nurse, x-ray machine) to be allocated at run time. Note that these specifications can set up contentions that can further constrain execution order, for example, by enabling or disabling concurrent execution.

My ED process model was developed based on the advice of a domain expert with extensive experience as an emergency physician and ED manager at the Baystate Medical Center, in Springfield, MA, USA. The full ED process model definition contains 178 activities, and is publicly available at <http://people.cs.umass.edu/~shin/ed/>. Figure 4.1 illustrates one small part of this process definition, namely the patient testing process for an acuity-level-four patient. Figure 4.1 specifies that AL4Test is a parallel activity, which means a lab test process, AL4LabProc, can be performed in parallel with the other tests, although contention for needed resources (in this case the MD) may make concurrency impossible. As the Figure 4.1 legend notes, activities may have prerequisites that may be used by my simulations to specify the relative frequency with which exceptions should be thrown, or which of the alternatives specified as the children of a choice activity is the one that should be selected. For example, the pre-requisite on AL4LabProc means that 92% of acuity-level-four patients require the lab test. For the other tests, a nurse checks a patient's EKG first, RNECG, and then a doctor checks the EKG result, MDckECG, because AL4ECGProc controls its child activities sequentially. After the EKG, a nurse gives medication to the patient, RNMedHi, and the patient is then transferred to either the CT or the x-ray room. This behavior is represented by the AL4XrayOrCTOrNothing choice activity, only one of whose child activities will be executed, with the choice made by the agent who performs the parent activity.

I used Little-JIL to define my ED process because Little-JIL makes it easy to define and represent visually some challenging, yet critical, features of the process. For example:

- **Allowing For Process Variation:** The Little-JIL choice activity makes it easy to show that patients can arrive either by ambulance, when they are immediately placed in a bed, or using their own transportation, with bed-placement based on classification into one of six acuity levels. The choice activity also facilitates showing the different treatment processes for the different levels.

- **Supporting Human Decision Making:** The choice activity also facilitates showing where humans are free to choose among alternatives. Thus, for example, the choice activity in Figure 4.1 modeled the doctor’s ability to choose either a CT or an X-Ray for the patient. The choice activity also concisely and precisely defined the way patients are given a bed-placement triage level between 1 and 5, and how this triage level is then used to determine if a bed is to be allocated now or deferred.
- **Concurrency:** Some activities in some of the treatment processes can be performed in parallel, and, indeed, further concurrency arises because the entire treatment process is performed once for each patient in the ED. This can create contention for resources such as MDs, RNs, and X-Ray machines, and makes the clear and precise specification of the exact nature of the concurrency particularly important. The Little-JIL parallel activity facilitates specifying this concurrency, and supports a clear visual depiction of that seems readily accessible to ED domain experts.
- **Exception Management:** It is common for non-normative situations to arise in EDs. For example, the lack of needed resources (e.g., beds, nurses) may necessitate changes in treatment sequences or substitution of resources, and treatment procedures that prove ineffective may necessitate new diagnostic procedures and diagnoses. The Little-JIL exception management facilities, featuring scoped handling of typed exceptions has proven particularly effective in defining clearly and precisely even difficult exception management scenarios [33].

4.2 Process- and Resource-Aware Discrete-Event Simulator

My process- and resource-aware discrete-event simulator simulates processes whose activities are modeled in Little-JIL, and whose resources are modeled in my resource modeling approach. To this end, I have extended JSim [52], an existing discrete-event simulator of Little-JIL processes. My extensions include support for (1) resource objects, (2) the two-phase resource reservation and allocation, (3) permission constraint policies,

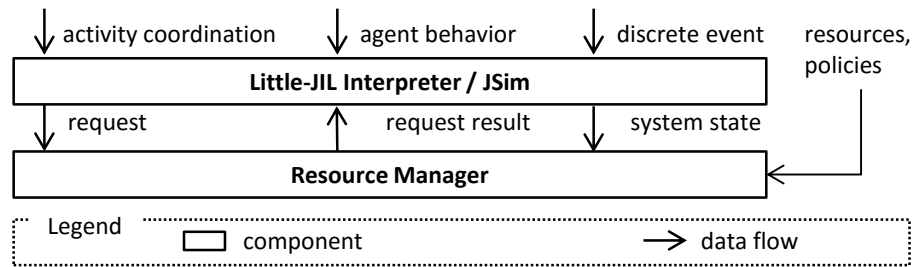

Figure 4.2. A view of the process- and resource-aware simulator that integrates JSim and Resource Manager.

(4) conflict resolution policies, and (5) contention policies to select preferred requests, selection policy constrains to select preferred resources. These extensions enable the simulator to support such scenarios as (1) allowing doctors to have varying shift constraints, (2) enforcing the same doctor always handles a given patient, unless the doctor’s shift ends, at which point the patient is handed off to a new doctor, (3) enabling a variety of scheduling policies, such as handing the sickest patient first, or using the least utilized resource first. Additionally I have redesigned the simulator’s architecture to improve the separation of concerns and localization of key aspects of the system.

Figure 4.2 shows the extended JSim architecture that integrates Resource Manager component. The architecture separates the activity issues from resource concerns, which makes it easy to keep track of resource allocations, utilizations, waiting times, and other properties that other simulators have difficulty reporting (see Section 7). In addition, extended JSIM treats resource policies as a separate concern, which eases changing them, facilitating experimentation with different resource allocation strategies.

The Little-JIL Interpreter is an abstract representation of a number of JSim components not related to resource management. The activity coordination artifact represents the Little-JIL activity definition. The agent behavior artifact specifies details (such as speed and cost) of the way in which resource objects provide their capabilities. The discrete event is an event arrival stream that triggers the execution of process

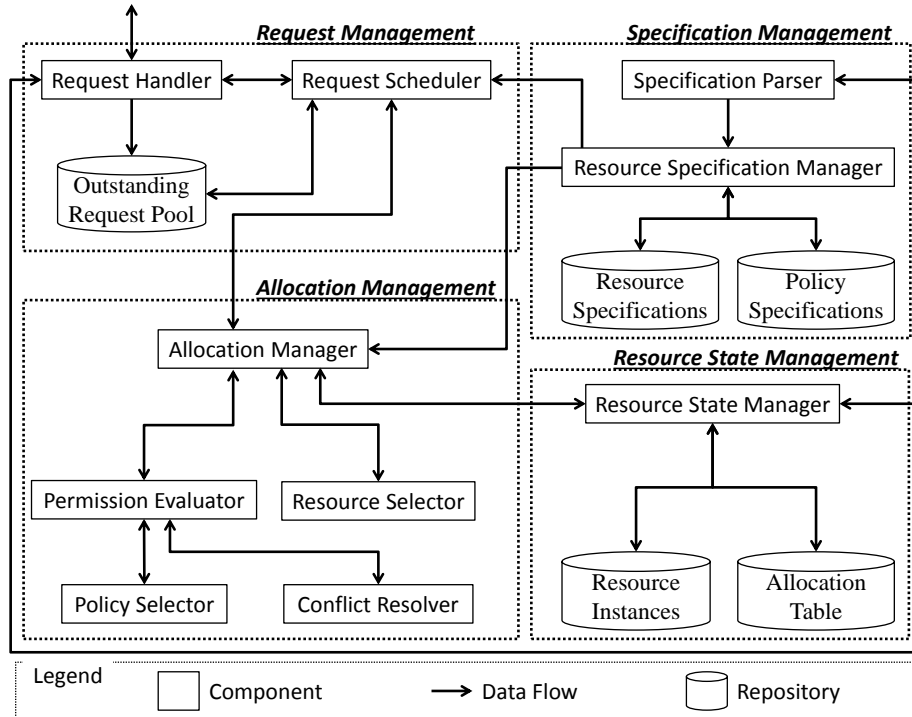

Figure 4.3. A resource manager architecture that enforces the specified resource utilization policies while allocating resources.

activities. During simulation, activities first allocate and then release resources by sending requests to Resource Manager, which enforces the policies associated with each request and determines which resources satisfy the request, and responds with either a satisfactory resource, or a message that the needed resource is unavailable.

4.2.1 Resource Manager Architecture

Given the formal specifications of resource characteristics, requests and utilization policies, I develop the architecture of the resource manager. This section explains the architecture by focusing on the policy enforcement of resource allocation.

Figure 4.3 shows the architecture of the resource manager. While executing a system, Request Handler inserts the number of requests that have arrived into Outstanding Request Pool. For instance, the requests for multiple patients who are waiting to be

seen by a doctor are located in Outstanding Request Pool. Request Scheduler selects a request based on a contention policy specification such as the sickest patient first policy, then passes it to Allocation Manager for matching a resource instance to the request. Such resource specifications are managed by Resource Specification Manager. Specifications of resource characteristics and utilization policies are located in Resource Specifications and Policy Specifications repositories, respectively. Based on the information of the selected request, Allocation Manager gathers related permission constraint policies from the Resource Specification Manager and resource instances from the Resource State Manager. Resource State Manager keeps the dynamic state information of the resource manager, such as the internal states of each resource instance and resource allocation traces. Policy Selector then selects a set of permission constraint policies to be evaluated based on the priority relations among policies. Permission Evaluator evaluates the selected permission constraint policies to decide a set of candidate resource instances for the selected request. For example, only doctors who are working their shifts are considered as candidates to care for a patient. If there are no candidate resource instances because of violation of the evaluated permission constraint policies, Conflict Resolver considers this case as a conflict among the permission constraint policies. Conflict Resolver resolves this conflicted situation based on a conflict resolution specification. If Permission Evaluator creates a set of candidate resource instances, Allocation Manager adjusts the candidates based on the resource capacity constraint. For instance, if a candidate doctor is caring for other patients at this point, Allocation Manager excludes the doctor from the set of candidate resource instances. Last, Resource Selector selects a resource instance among the available candidates according to the selection policy related to the request.

```

<step name="RNECG"> <started> <complete>
  <triangular min="233" mode="313" max="472" />
</complete> </started> </step>

<step name="MDCKECG"> <started> <complete>
  <triangular min="11" mode="36" max="88" />
</complete> </started> </step>

<step name="RNMedHi"> <started> <complete>
  <triangular min="181" mode="448" max="856" />
</complete> </started> </step>

```

Figure 4.4. These time distributions of steps are modeled from data of Baystate Medical Center, in Springfield, MA, USA. Second time unit is used in triangular distribution.

4.2.2 Specification of Simulation

A simulation run consisted of specifications of process activities, artifact flows, resources, resource requests, and resource utilization policies (recall Chapter 3), as well as specifications of actual patient-care scenarios whose key variable components are: (1) rates of arrivals of patients of different acuity levels over a 24-hour period and (2) activity performance characteristics (such as the amount of time taken, the probability of exceptions, etc.) for each resource object that might carry out each activity. The specifications used in my simulations were based on observations taken at the Baystate Medical Center, in Springfield, MA, USA. Each hourly patient arrival rate was modeled as a Poisson distribution around the observed mean inter-arrival time. Resource quantities, characteristics, and constraints were modeled after those considered typical at the Baystate Medical Center.

Estimates of the time required to perform each activity for each acuity level are specified as triangular distributions based on data from the Baystate Medical Center. My medical domain expert advised the use of the triangular distribution due to the small number of observed time data. Figure 4.4 shows an example specifying the time distributions of three leaf activities, RNECG, MDCKECG and RNMedHi, of the process shown in Figure 4.1. Thus, for example, from the start of the RNECG activity the number of second until completion of

the activity is calculated to occur using the triangular distribution, (min=233, mode=313, max=472). My simulation specifications also support other distributions such as normal, linear range, and fixed time distributions.

4.3 Constraint-Aware Resource Scheduling

My process- and resource-aware discrete-event simulation framework facilitates analyzing resource utilization and exploring diverse resource utilization policies through the separation of resource concerns. Given the simulation framework, I develop a method for scheduling resources in complex systems that integrate humans with diverse hardware and software components, and for studying the impact of resource schedules on system characteristics. The method uses discrete-event simulation and integer linear programming (ILP), and relies on detailed models of the system's processes, specifications of the capabilities of the system's resources, and constraints on the operations of the system and its resources. For exposition, this section addresses staffing problem in a hospital ED because of its particularly complex resource scheduling requirements.

4.3.1 Simulation-based Staffing Optimization

Simulation-based staffing algorithm dynamically estimates and controls utilization within pre-specified limits by changing the utilization levels of multiple human resources simultaneously in complex service systems, and linking the resulting estimates to an ILP that incorporates realistic staffing and shift constraints. Specifically, my approach consists of three steps.

In the first stage, I use my simulator to generate an ED simulation, initially assuming an infinite supply of all necessary resources. As this ED simulation executed, however, the simulator add and remove resources as required to sustain the utilization targets for each hour in the simulated 24-hour day, while also considering such other specifications as time varying patient arrivals, different processes for each acuity level, resource interactions, and

other patient flow constraints. I call this the Staffing Demands Algorithm. The number of replications of this simulation was determined by the desire to achieve a target confidence interval (e.g., 95% confidence interval and a half-width within 2% of the mean of staff utilization rates). After performing these simulation replications, I obtain the average number of resources d_b^k required in time interval b to maintain the utilization target. For my case-study, b is the index for hour of the day, and k refers type of staff - in my case, either MDs or RNs. The exact details of how d_b^k is computed is provided in Section 4.3.1.1.

In the second stage, I use d_b^k , $b = (0, 1), (1, 2), \dots, (23, 0)$, as input to an ILP whose purpose was to obtain the minimum cost staffing schedule. The decision variables of the ILP determine the number of type k resources to be scheduled in hour b to assure that the number is greater than or equal to d_b^k . I also model some typical restrictions on shift lengths and starting times, but also do studies where I model possible overlaps in shifts and differences in shift lengths. The output of this second stage is x_b^k , the number of resources of type k that need to be scheduled in hour b to minimize the total cost of salaries while meeting the required constraints. The details of the ILP are provided in Section 4.3.1.2.

In the third stage, the staff schedule computed from the second stage ILP is used to specify the exact numbers of MD and RN resources available for each hour in the simulated 24-hour day. I then run simulations using these staffing levels, and the other modeling information as described in Chapter 3 to determine operational characteristics such as patients' length of stay, waiting times, contribution margin, and the actual utilization levels of the resources (which, depending on the staffing constraints, could differ from original targets), the number of patient handoffs etc.

For my studies, I ran batteries of simulations based on many different hypotheses about staff utilization, shift length variation, shift overlapping, etc. Each different hypothesis required carrying out all three of the stages just described. Each produced operational characteristics that I used to compare and evaluate the effects of these different choices of staff utilization levels and scheduling approaches. The results are presented in Chapter 6.

I now provide details of how I carry out each of these three stages in my simulation approach.

4.3.1.1 Simulation-based Resource Requirement Determination

As the number of patient arrivals varies by the hour, the number of resources required will also need to be varied so that the utilization of the resource remains within the pre-specified utilization limits. The goal of the staffing demands algorithm is to dynamically compute this distribution of required numbers of resources in the middle of a simulation run. This approach allows the algorithm calculates the resource demands based on the consideration of dynamic ED contexts such as patients' arrivals/waits, utilization of other resources (e.g., beds), interactions between resources, and other ED circumstances. In addition, my algorithm can be executed on multiple resource types such as MD and RN at the same time period during a simulation run.

Before I describe the algorithm, I distinguish between resource sets as follows. I assume that there are some resources that are available for use during the entire duration of the b th hour. In addition, there may also be other resources that may be used for some portion of the hour, because they continue to be used to finish an activity that was begun during the previous hour. For instance, if an MD's shift ends before completing an x-ray check for a patient, the MD will complete the x-ray check step thereby providing some amount of MD resource during an hour that is beyond the MD's original shift. Thus these additional incremental amounts of resource availability must be added to the resource levels provided by scheduled resources to accurately determine the levels of resources required for each hour in the 24-hour day. When the MD completes the x-ray check step, the remaining steps to care for the MD's patients in beds are handed over to the other available MDs. This kind of overtime work of a medical provider is frequently observed in real-world EDs. However, my simulator does not supporting preemption. Which means that a handoff in the middle of an activity execution is not supported. Due to this limitation, patient care steps in the

ED model are decomposed enough to model atomic activities in patient care that spend small amount of time to prevent extensive overtime work. The notations in the algorithm for staffing demands are:

- i time interval between resource adjustment
- l lower utilization limit to trigger decrementation of the number of resources required for this time interval, $0 < l \leq u$
- u upper utilization limit to trigger incrementation of the number of resources required for this time interval, $0 < u \leq 1$
- b time block tuple (f, t) from time f to t where $|t - f| = i$
- k resource type
- r_b sum of busy periods for resource r during time block b
- d_b^k staffing demand, the number of required staff, for resource r of type k during time block b
- R^k a set of resources of type k for which I want to determine required staffing levels
- R_b^k a set of resources of type k that are used during time block b , $R_b^k \subseteq R^k$
- A_b^k a set of resources of type k that are available to be assigned during time block b , $A_b^k \subseteq R_b^k$, $A_{(0,i)}^k = R^k$ where $(0, i)$ is the first time block

Figure 4.5 describes the staffing demands algorithm. R_b^k is the set of used resources of type k during time block b . A_b^k is the set of available resources of type k during time block b which means that only resource $r \in A_b^k$ is available to be assigned during time block b . Further, $A_b^k \subseteq R_b^k$.

For example, Figure 4.6 shows the execution of the algorithm for a single instance. As per lines 7-15 of the algorithm, the resource utilization during time block $b = (t - i, t)$ is calculated. Here, $R_b^k = \{r_1, r_2, r_3\}$ since resources r_1, r_2 and r_3 are used from time $t - i$ to t . However, $A_b^k = r_2, r_3$ because resource r_1 left at time c (some amount of resource utilization in this time period was attributable to the overflow into this time period of some work begun during the previous period). Therefore, $r_{1b} = c - (t - i)$. After the algorithm calculates

```

1  StaffingDemands, AvailableResources
2  calculateStaffingDemands (
3      double l, double u,
4      Time t, Time i,
5      ResourceType k) {
6
7      // calculate resource utilization
8      TimeBlock b = (t-i, t);
9      double denominator = 0;
10     double numerator = 0;
11     for (∀ Resource r : r ∈ Rbk) {
12         denominator += (r ∈ Abk) ? i : rbi;
13         numerator += rbi;
14     }
15     double utilization = numerator/denominator;
16
17     // calculate staffing demands
18     StaffingDemands dbk = 0;
19     if (utilization ≥ l &&
20         utilization ≤ u) {
21         dbk = count(Abk);
22     } else {
23         double middle = (l+u)/2;
24         dbk = round(numerator/(middle*i));
25     }
26
27     // select available resources
28     TimeBlock nb = (t, t+i);
29     AvailableResources Anbk = {};
30     while(count(Anbk) != dbk) {
31         Resource r : r ∈ Rk;
32         Anbk = Anbk ∪ {r};
33     }
34
35     return dbk, Anbk
36 }

```

Figure 4.5. Given the upper and lower utilization limits, the algorithm calculates how many resources of type k are required during time block $b = (t - i, t)$ and adjusts the number of available resources of type k to be assigned for next time block $nb = (t, t + i)$.

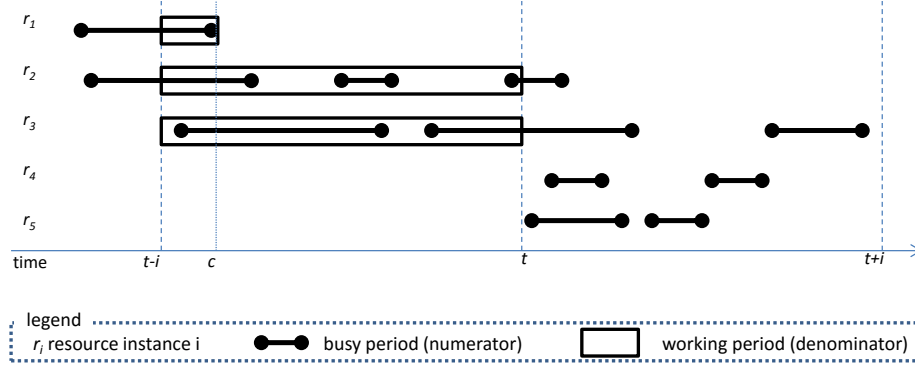

Figure 4.6. An instance of the algorithm execution for staffing demands: $R_b^k = \{r_1, r_2, r_3\}$, $A_b^k = \{r_2, r_3\}$, $d_b^k = 3$, $R_{nb}^k = \{r_2, r_3, r_4, r_5\}$, $A_{nb}^k = \{r_3, r_4, r_5\}$ where $b = (t - i, t)$, $nb = (t, t + i)$

utilization at line 15, it determines how many resources are required to satisfy the desired range of utilization levels l and u (lines 17-25). If the calculated *utilization* is between l and u , it means that resources in A_b^k are utilized as expected. However, if *utilization* is outside the limits l and u , the algorithm calculates staffing demands d_b^k based on the mid-point of the utilization range $middle = (l + u)/2$ and actual assigned sub-periods *numerator* during time $t - i$ to t .

In addition to calculating staffing demands d_b^k , the algorithm adjusts the numbers of resources A_{nb}^k for next time block, i.e., from t to $t + i$ (lines 27-33). The adjustment assumes that there are no dramatic changes in patient arrivals in this next period. Therefore, I use d_b^k to decide the size of A_{nb}^k .

4.3.1.2 Staffing via Integer Linear Programming (ILP)

In this section, I present my ILP-based staffing approach, which minimizes total staff salaries, while meeting (a) hourly constraints on staff numbers calculated by the previously-described staffing demands algorithm, and (b) constraints on allowed shift lengths and shift start times. The ILP-based staffing approach divides a day into several discrete time blocks (each an hour in length in my case-study). The ILP parameters are listed below.

B a set of time blocks in a day

- L^k a set of shift lengths for resource type k
- $S_{b,l}^k$ a set of time blocks in a shift for resource type k where shift starting time block $b \in B$, shift length $l \in L^k$
- d_b^k staffing demands, the number of required resource, for resource type k during each time block $b \in B$
- $p_{b,l}^k$ a staffing pattern for resource type k of a hospital
 - 1 if a shift begins a time block $b \in B$ and its shift length is $l \in L$;
 - 0 otherwise
- c^k staffing cost per hour for resource type k

For instance, Figure 4.7 shows the ILP parameter values needed to determine MD staffing levels. Parameter B divides a day into twenty four time blocks. Parameter $p_{b,l}^{MD}$ establishes three eight-hour, non-overlapping shifts a day for MDs. The staffing pattern parameter $p_{b,l}^{MD}$ can encode any staffing patterns of various shift lengths and start times; however, this section demonstrates only this three shifts of MD for exposition. MD staffing demand d_b^{MD} is assumed to have been derived using my previously-described simulation-based algorithm.

Alternatively, if an ED administration desires more flexibility to meet hourly variation in demands, they may allow MDs and RNs to work a six, eight or twelve hour shift; further, they may also allow shifts to start at any time. To accommodate this additional flexibility, the ILP parameters for RN can be set as in Figure 4.8.

The decision variable in the ILP is $x_{b,l,i}^k$, which determines the number of a particular staff type (e.g., MD or RN) needed in each hour of a shift. The number of $x_{b,l,i}^k$ is equal to $|B| \times |L^k| \times |B|$ for all b, l, i combinations. I use the simplex method to solve the ILP, NP-hard problem.

- $x_{b,l,i}^k$ the number of staff k in time block i in a shift
 - the shift starts at a time block b and its length is $l \in L^k$

B : $\{b_0, b_1, b_2, b_3, b_4, b_5, \dots, b_{19}, b_{20}, b_{21}, b_{22}, b_{23}\}, b_i = (i, i + 1)$

L^{MD} : $\{8\}$

$S_{b,l}^{MD}$: $S_{b_0,8}^{MD} = \{b_0, b_1, b_2, b_3, b_4, b_5, b_6, b_7\}, \dots,$
 $S_{b_{23},8}^{MD} = \{b_{23}, b_0, b_1, b_2, b_3, b_4, b_5, b_6\}$

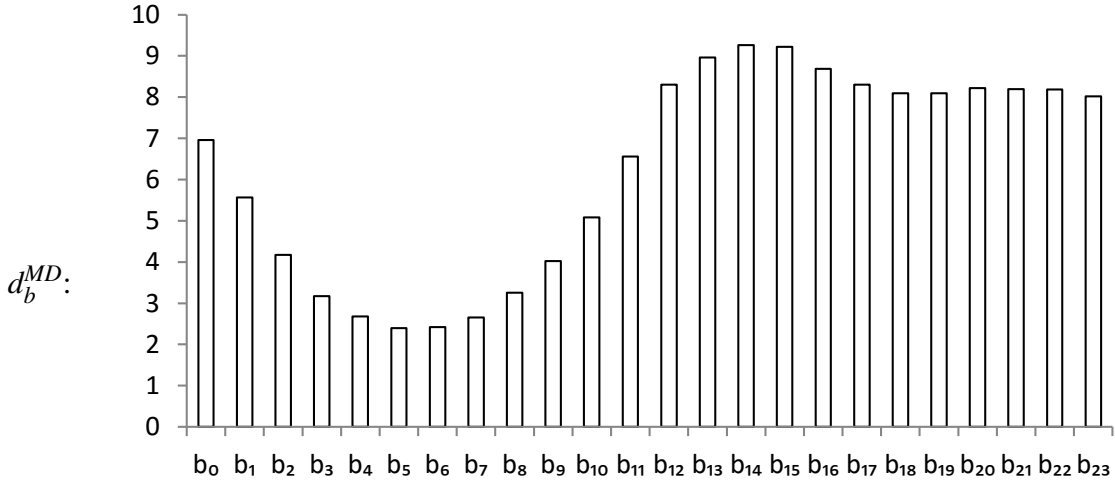

$P_{b,l}^{MD}$: $p_{b_7,8}^{MD} = p_{b_{15},8}^{MD} = p_{b_{23},8}^{MD} = 1, \forall b \in B \setminus \{b_7, b_{15}, b_{23}\}, p_{b,8}^{MD} = 0$

c^{MD} : USD188/hour

Figure 4.7. Parameter values for MD staffing. B : twenty four time blocks. L^{MD} : 8-hour shift length. $S_{b,l}^{MD}$: time blocks in l length shift b . d_b^{MD} : staffing demands per each time blocks driven by 70%–80% utilization target. $p_{b,l}^{MD}$: non-overlapped three, 8-hour shifts. c^{MD} : salary per hour.

The ILP-based staffing fulfills staffing demands d_b^k , the minimum number of required staff during each time block b . Equation (4.1) is the objective function of the ILP-based staffing problem. The ILP objective function aims to minimize total staffing costs per day.

$$\min \sum_{b \in B} \sum_{l \in L^k} \sum_{i \in B} c^k \cdot x_{b,l,i}^k \quad (4.1)$$

The objective equation (4.1) is subject to the constraint equations (4.2), (4.3), and (4.4). First, constraint equation (4.2) enforces that the number of scheduled staff k is always greater than or equal to the number of required staff k for all time blocks while satisfying a given staffing pattern. Second, constraint equation (4.3) states that the same number of staff k

B : $\{b_0, b_1, b_2, b_3, b_4, b_5, \dots, b_{19}, b_{20}, b_{21}, b_{22}, b_{23}\}, b_i = (i, i + 1)$

L^{RN} : $\{6, 8, 12\}$

$S_{b_0,6}^{RN} = \{b_0, b_1, b_2, b_3, b_4, b_5\}, \dots,$

$S_{b_{23},6}^{RN} = \{b_{23}, b_0, b_1, b_2, b_3, b_4\},$

$S_{b_0,8}^{RN} = \{b_0, b_1, b_2, b_3, b_4, b_5, b_6, b_7\}, \dots,$

$S_{b_{23},8}^{RN} = \{b_{23}, b_0, b_1, b_2, b_3, b_4, b_5, b_6\},$

$S_{b_0,12}^{RN} = \{b_0, b_1, b_2, b_3, b_4, b_5, b_6, b_7, b_8, b_9, b_{10}, b_{11}\}, \dots,$

$S_{b_{23},12}^{RN} = \{b_{23}, b_0, b_1, b_2, b_3, b_4, b_5, b_6, b_7, b_8, b_9, b_{10}\}$

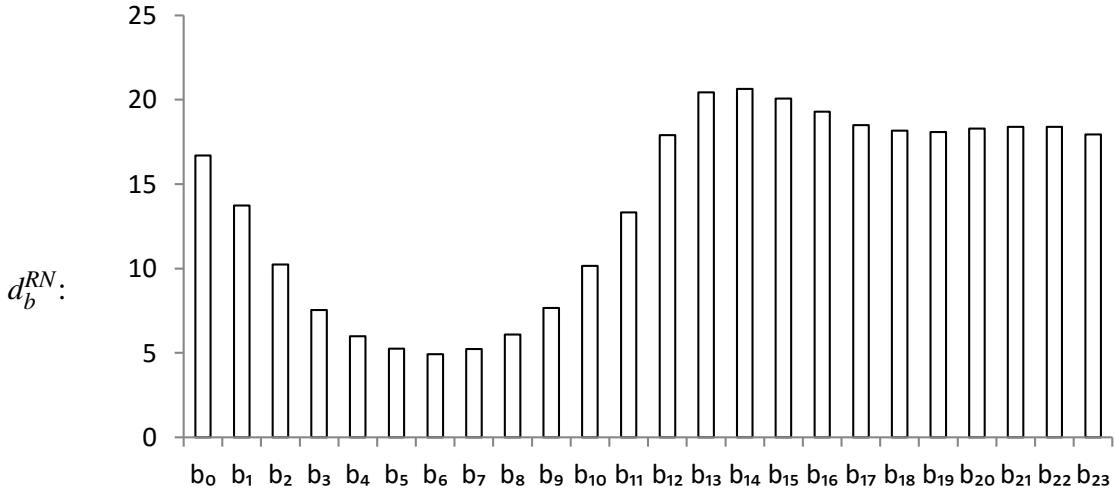

$p_{b,l}^{RN}$: $\forall b \in B, \forall l \in L^{RN}, p_{b,l}^{RN} = 1$

c^{MD} : USD55/hour

Figure 4.8. Parameter values for RN staffing. B : twenty four time blocks. L^{RN} : 6,8,12-hour shift lengths. $S_{b,l}^{RN}$: time blocks in l length shift b . d_b^{RN} : staffing demands per each time blocks driven by 60%–70% utilization target. $p_{b,l}^{RN}$: three different shift lengths, and the staffing pattern allows a shift to start at any time. c^{RN} : salary per hour.

members are working in a shift. Last, constraint equation (4.4) assures that a staff k member is working on only the staff's shift.

$$\sum_{b \in B} \sum_{l \in L^k} p_{b,l}^k \cdot x_{b,l,i}^k \geq d_i^k, \forall i \in B \quad (4.2)$$

$$x_{b,l,i}^k = x_{b,l,j}^k, \forall i \in S_{b,l}^k, \forall j \in S_{b,l}^k \quad (4.3)$$

i	0	1	2	3	4	5	6	7	8	9	10	11	12	13	14	15	16	17	18	19	20	21	22	23
$x_{(7,8),8,i}^{MD}$								9	9	9	9	9	9	9										
$x_{(15,16),8,i}^{MD}$																8	8	8	8	8	8	8	8	
$x_{(23,0),8,i}^{MD}$	8	8	8	8	8	8	8																	8

Figure 4.9. MD staffing solution of Figure 4.7. Three separate shifts, 7–14, 15–22 and 23–6. Each shift has 9, 8 or 8 MDs.

$$x_{b,l,i}^k = 0, \forall i \in B \setminus S_{b,l}^k \quad (4.4)$$

To illustrate how the ILP works, an MD staffing solution for Figure 4.7 is displayed in Figure 4.9. There are three separate shifts, 7–14, 15–22 and 23–6. Each shift has 9, 8, or 8 MDs, respectively.

However, the RN staffing solution in Figure 4.10 looks very different from the MD staffing in Figure 4.9. This is because the ILP parameters for RN staffing in Figure 4.8 allow three different shift lengths, and a shift can start at any time (i.e., overlap in shifts are allowed). Therefore, RN staffing in Figure 4.10 very closely approximates actual RN staffing demands d_b^{RN} in Figure 4.8. I return to this key point while discussing the results of actual simulations carried out as the third stage of my simulation-based staffing approach.

i	0	1	2	3	4	5	6	7	8	9	10	11	12	13	14	15	16	17	18	19	20	21	22	23	
$x_{(0,1),8,i}^{RN}$	2	2	2	2	2	2	2	2																	
$x_{(1,2),8,i}^{RN}$		1	1	1	1	1	1	1	1																
$x_{(7,8),6,i}^{RN}$									3	3	3	3	3	3											
$x_{(8,9),6,i}^{RN}$									4	4	4	4	4	4											
$x_{(9,10),6,i}^{RN}$										3	3	3	3	3	3	3									
$x_{(10,11),12,i}^{RN}$											4	4	4	4	4	4	4	4	4	4	4	4	4	4	
$x_{(11,12),6,i}^{RN}$												1	1	1	1	1	1								
$x_{(11,12),8,i}^{RN}$												3	3	3	3	3	3	3	3						
$x_{(12,13),12,i}^{RN}$													4	4	4	4	4	4	4	4	4	4	4	4	
$x_{(13,14),12,i}^{RN}$	4													4	4	4	4	4	4	4	4	4	4	4	
$x_{(14,15),6,i}^{RN}$															4	4	4	4	4	4					
$x_{(15,16),12,i}^{RN}$	2	2	2													2	2	2	2	2	2	2	2	2	
$x_{(19,20),12,i}^{RN}$																					3	3	3	3	
$x_{(20,21),6,i}^{RN}$																						4	4	4	
$x_{(21,22),8,i}^{RN}$																							1	1	1
$x_{(22,23),6,i}^{RN}$																								3	3

Figure 4.10. RN staffing solution of Figure 4.8. Sixteen overlapped shifts. Shifts have different lengths and start times. Total number of RNs 46 and RNs working hours 392.

CHAPTER 5

STATIC ANALYSIS THROUGH PROCESS- AND RESOURCE-AWARE MODEL CHECKING

My process- and resource-aware discrete-event simulation shows promising results for the evaluation of diverse resource utilization policies in a flexible manner. However, dynamic verifications via simulations are inherently unable to exhaustively execute all possible simulation scenarios. To address this limitation, I develop a novel approach to analyze resource utilization policies statically based on the use of an existing static analysis technique.

Static analysis techniques, in general, investigate a system without performing actual executions to verify whether a system holds a given property. Model checking is a static analysis technology that has long been used in order to either demonstrate that all possible executions of a program always adhere to specified properties, or to identify one or more paths on which a property can be violated. In this past work, the properties were typically event sequence specifications characterizing program functionality. In this current work, I have used this technology to statically verify that all simulation executions always adhere to resource utilization properties. I believe such verifications should increase the credibility of the results of my simulation studies.

5.1 Resource-Aware Static Analysis

This section describes motivating examples that show the issues of omitting resource concerns in static analysis and demonstrate how my resource-aware static analysis addresses the issues. Each example includes a control flow graph. A node in the graph may require

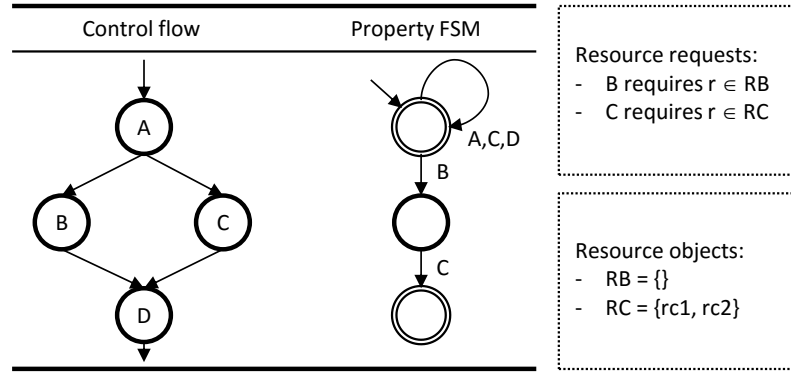

Figure 5.1. An example that shows the difference in verification results between the analysis technique **C** and **R**. **C**-the property does not hold. **R**-the property holds.

a resource object to be executed, and a property FSM that specifies the desired sequences of execution events of the control flow. In a property FSM, a solid circle is an unaccepting state while a double circle is an accepting state. For purposes of explanation in this section, I assume there are two static analysis techniques named **C** and **R**:

C a static analysis technique that analyzes only a control flow and a property FSM

R a static analysis technique that analyzes a control flow with resource utilization and a property FSM

Figure 5.1 shows an example that results in the different verification outputs depend on the consideration of resource utilization in a static analysis. The control flow graph has two feasible execution traces without considering resource utilization such as A, B, D and A, C, D . Given the feasible traces, the trace A, B, D is not held by the property FSM. However, the trace A, B, D is actually infeasible because B node requires $r \in RB$, but $RB = \{\}$. Therefore, **C** technique analyzes the property does not hold; however, **R** technique analyzes the property holds.

The example system in Figure 5.2 results in different verification outputs from Figure 5.1. Using the analysis technique **C**, both traces A, B, D and A, C, D in the control flow graph are held by the property FSM. However, this example system does not have any resource

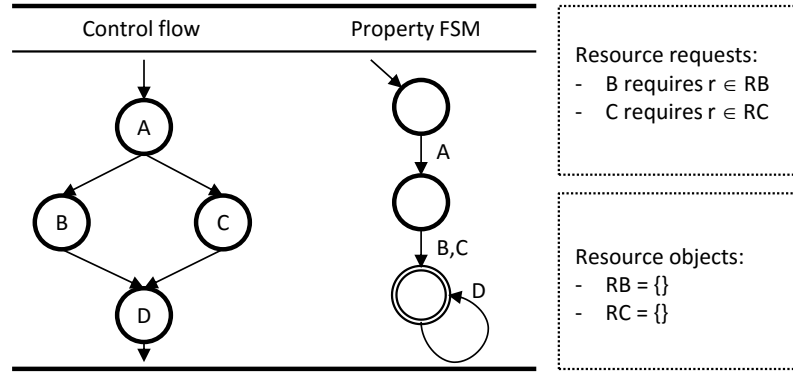

Figure 5.2. An example that shows the different verification results between the analysis technique **C** and **R**. **C**-the property holds. **R**-the property does not hold.

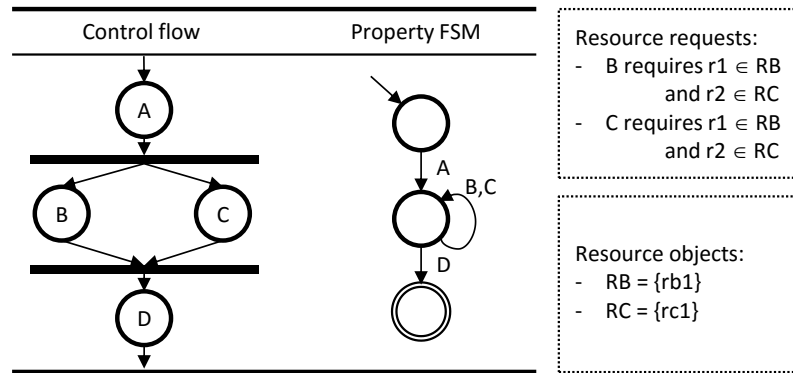

Figure 5.3. An example that shows the difference in verification results between the analysis technique **C** and **R** caused by resource deadlock. **C**-the property holds. **R**-the property does not hold.

objects ($RB = \{\}$ and $RC = \{\}$). Therefore, **R** technique analyzes the property does not hold because in that situation both A, B, D and A, C, D are infeasible.

The control flow in Figure 5.3 has two feasible traces A, B, C, D and A, C, B, D assuming atomicity of all nodes in the control flow without considering resource utilization. Both A, B, C, D and A, C, B, D are held by the given property using **C** technique. However, analysis by **R** resource-aware static analysis technique reveals that the property does not hold if the semantic of resource allocations allows the following resource utilization scenario. B node in the control flow graph requires two resource objects of $r1 \in RB$ and $r2 \in RC$. C node

also requires two resource objects of $r1 \in RB$ and $r2 \in RC$. However, if B acquires $rb1$ and C acquires $rc1$, both B and C nodes are not able to make progress. This trace of resource deadlock is not held by the property FSM.

In addition to considering functional control events (A, B, C, and D events in this section), resource events such as resource allocations and releases help analysts specify property FSMs. My resource-aware static analysis allows analysts to describe the desired utilization of resources as property FSMs based on using resource events.

5.2 Platform for Process- and Resource-Aware Finite State Verification

My static analysis of resource utilization relies on the use of FLAVERS [21]: FLOW Analysis for VERification of Systems. To be specific, I develop my static resource analysis approach based on FLAVERS/Little-JIL [10] which provides the Little-JIL to BIR (Bandera Intermediate Representation) [27] translation method. This section describes background information of FLAVERS and BIR which are relevant to my approach.

5.2.1 FLAVERS: FLOW Analysis for VERification of Systems

FLAVERS is a model checking tool that can verify that all executions of a system satisfy a given property or will report a counterexample scenario that violates the property. This counterexample helps analysts identify the reason for the violation. FLAVERS requires three kinds of inputs for verification: a trace flow graph (TFG), a property FSM, and a set of constraint FSMs. A TFG is a conservative representation of all syntactically-feasible event execution sequences of a system. A property FSM is a representation of a mechanism for accepting only desired system event execution sequences. A property FSM has special acceptance states to check the satisfaction of a property. A constraint FSM is a representation of a mechanism for identifying when a system event execution sequence violates a specific

constraint that causes the sequence to become unacceptable. A constraint FSM has special trap states to eliminate infeasible execution paths.

Given the three kinds of inputs, FLAVERS uses the state propagation algorithm to verify whether all the execution paths of the given TFG always satisfy the property FSMs. The analysis algorithm associates a set of tuples of states in the property FSMs and constraint FSMs with each event node in the TFG. While propagating the tuples based on events in the TFG, if a constraint FSM reaches a trap state, a corresponding execution path is excluded from the analysis searching space. If a property FSM stays in an acceptance state at the end of state propagation, analysis guarantees the system executions represented in the TFG hold the property FSM.

Constraint FSMs in FLAVERS allow analysts to refine the entire system model incrementally. TFG is a conservative representation of system executions that includes infeasible execution paths in a system. Therefore, even though FLAVERS reports a counterexample, this may not actually occur in real system executions. However, FLAVERS incorporates constraint FSMs to exclude infeasible paths. This approach helps analysts add complexity incrementally to analyze the entire system in a tractable manner.

5.2.2 BIR: Bandera Intermediate Representation

BIR is a guarded command language designed to support the translation of Java programs to a variety of model checkers. FLAVERS/Little-JIL translates Little-JIL specifications to a BIR program that consists of variable declarations, threads, and predicates. Given the BIR program, FLAVERS/Little-JIL generates the inputs of FLAVERS to verify Little-JIL specifications. This section describes BIR features which are relevant to understand my BIR templates, that encodes resource utilization policies, described in the following sections.

BIR supports seven basic types of variables such as boolean, integer range, enumerated, locks, arrays, records, and references. Among them, I use boolean and integer range variables to encode the use of resources. An activity can be started only after necessary resource

objects have been allocated. A boolean variable is used to check whether a necessary resource object is allocated or not. A request is often handled by one of multiple candidate resource objects. These candidate resource objects are encoded by using an integer range variable. The integer range variables are also used to enforce resource utilization policies that restrict an allocation of a specific resource objects.

A BIR program is a single process consist of multiple threads. A thread is a directed graph with a set of locations and transitions constrained by guard expressions. The thread structure of a BIR program is determined by a given process specification which includes various sequencings such as parallels, choices, and exceptions. States of an activity such as `STARTED` and `COMPLETED` are encoded in a single BIR thread. I encode resource utilization for each activity in an associated thread to the activity. A resource utilization policy often restricts the use of resources over multiple activities in multiple threads. The enforcement of the policy is encoded by using global variables that are accessible from multiple threads.

Predicates in a BIR program are named boolean expressions to capture states of the BIR transition system. I use predicates to test thread locations which are related to resource utilization of the system and a given resource property FSM. A predicate to test thread location is evaluated to be true when the indicated thread is at the corresponding location. These predicates are eventually used to generate resource events while FLAVERS is analyzing a translated trace flow graph.

5.2.3 XPath: XML Path Language

XPath [74] is used to navigate through the elements and attributes in an XML document. XPath selects a set of nodes through a hierarchic navigation path of a XML document tree. Path expressions of XPath are similar to the file paths of a traditional computer file system. For instance, an XPath expression `/a/b` means that `/a` selects the `a` element, then `/b` selects all the `b` elements under the `a` element in an XML document. I use XPath expressions to

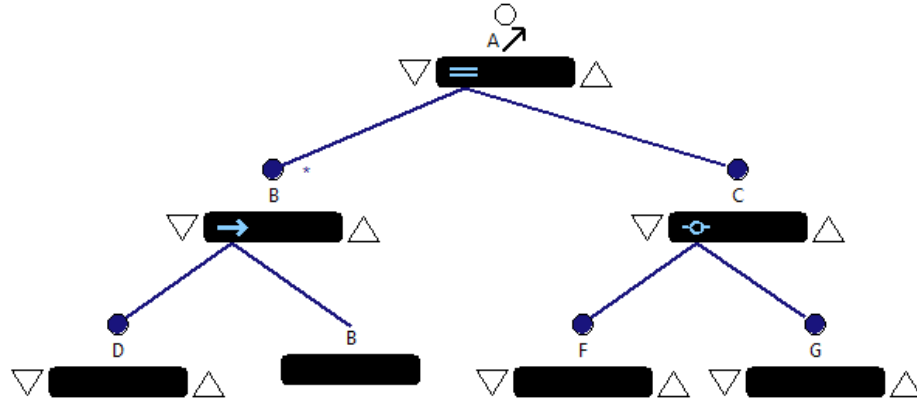

Figure 5.4. Little-JIL diagram to illustrate how to use XPath expressions to navigate activities.

```

1  <A UID="A_0">
2    <B UID="B_1">
3      <D UID="D_2">/D>
4      <B UID="B_3">
5        <D UID="D_4"></D>
6        <B UID="B_5"></B>
7      </B>
8    </B>
9    <B UID="B_6">
10     <D UID="D_7"></D>
11     <B UID="B_8">
12       <D UID="D_9"></D>
13       <B UID="B_10"></B>
14     </B>
15   </B>
16   <C UID="C_11">
17     <F UID="F_12"></F>
18     <G UID="G_13"></G>
19   </C>
20 </A>

```

Figure 5.5. XML representation of an unrolled Little-JIL diagram in Figure 5.4. This XML document is used only for purposes of explaining XPath.

navigate through activities in a graphical Little-JIL specification. XPath expressions are used in specifying a resource property which is described in the following Section 5.3.4.

XPath expression	Activities in Figure 5.4 (Activities in Figure 5.5)
//*	all activities (all activities)
/A/C	C activity (C UID="C_11")
/A/B[1]//*	all activities under the first occurrence of B activity. (D UID=D_2, B UID=B_3, D UID=D_4 , B UID=B_5)
/A//F	F activity (F UID="F_12")

Figure 5.6. XPath expression examples that select activities in Figure 5.4.

Figure 5.4 is an example Little-JIL diagram to illustrate how to use XPath expressions to navigate activities in the specification. XPath expressions for Little-JIL are specified based on an unrolled Little-JIL structure. In this example, the \star cardinality above the B activity indicates that there are zero or many B activities having child activities. In addition, the B reference activity without including child activities represents a recursion to repeat the D activity. To explain XPath expressions for Little-JIL, I use an XML document which describes an unrolled Little-JIL structure. Figure 5.5 is an XML document which describes an unrolled Little-JIL diagram in Figure 5.4 by fixing the \star cardinality to be 2 and repeating the D activity twice. As can be seen in Figure 5.5, sequencing information in Figure 5.4 is omitted because the information is not required to distinguish each activity in a Little-JIL diagram by using XPath. Figure 5.6 shows some example pairs of XPath expression and a set of selected activities in Figure 5.4 which help to clarify XPath expressions in the remaining sections.

5.3 Process- and Resource-Aware Model Checking

Figure 5.7 shows the overview of my static resource analysis approach. I extend the components at Translation part of FLAVERS/Little-JIL. Process Builder cre-

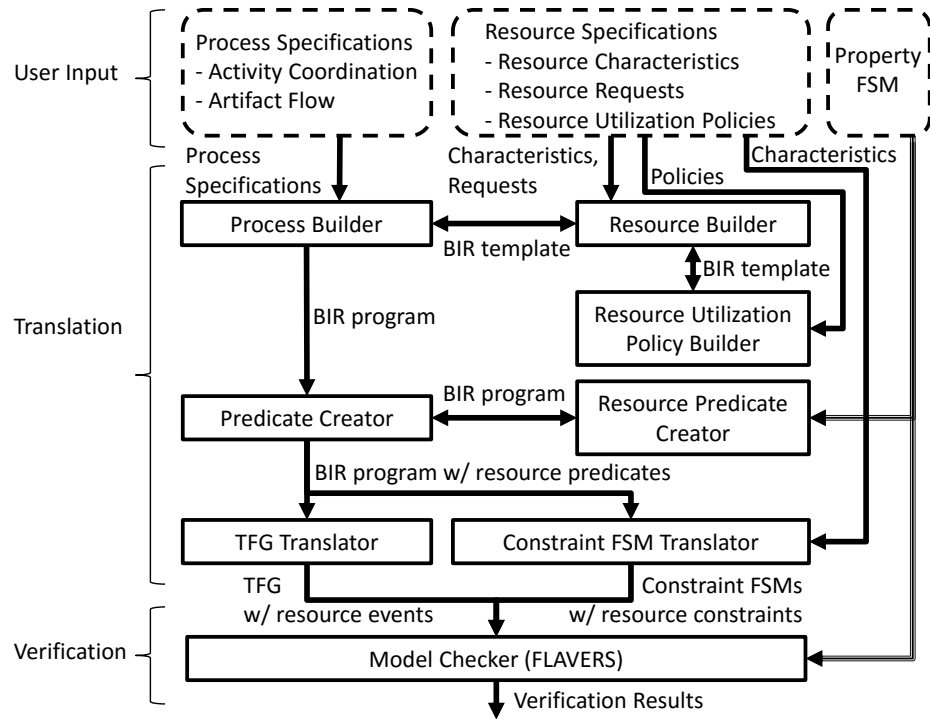

Figure 5.7. Overview of static process- and resource-aware model checking approach. My approach translates resource specifications into the inputs of FLAVERS.

ates a BIR template for each activity based on given Process Specifications that include Activity Coordination and Artifact Flow. Process Builder collaborates with Resource Builder to encode resource allocation and release behaviors into a BIR template. Resource Builder uses the specifications of Resource Characteristics and Resource Requests to encode which resource objects must be allocated and released for a request. Resource Utilization Policy Builder is responsible for extending a BIR template to enforce resource utilization policies based on the specifications of Resource Utilization Policies. Predicate Creator creates necessary predicates to generate events at the Verification phase. Resource Predicate Creator makes predicates associated with resource events such as resource reservations, assignments, and releases related to Constraint FSMs and Property FSM for a resource property verification. TFG Translator converts the BIR program to a TFG with resource events for allocations

(reservations and assignments) and releases. Constraint FSM Translator generates a set of constraint FSMs including resource constraints such as resource capacity constraints based on a BIR program and the specifications of Resource Characteristics. Model Checker (FLAVERS) takes the TFG and Constraint FSMs as inputs to verify whether the system specifications satisfy a given Property FSM.

5.3.1 BIR Translation Templates Encoding Resource Utilization

FLAVERS/Little-JIL provides seven BIR template types to encode Little-JIL semantics such as an activity start, completion, and other activity execution semantics. This section presents seven new BIR templates by focusing on resource utilization.

5.3.1.1 BIR Template: Single Resource Allocation

Figure 5.8 is a BIR template that encodes resource allocation traces to handle a single request from an activity. The template takes three parameters: `Activity`, `Query`, and `RequestMode`. `Activity` is an activity object which sends a request. `Activity` information comes from the specification of activity coordination. A request information described in the resource request specifications is further decomposed into `Query` for a required capability and `RequestMode` for either reservation or assignment. `ResourceVar` is an integer range variable that encodes the number of resource objects which can handle the given request. The integer range is determined by the specifications of resource characteristics that describe the number of resource objects and sets of capabilities which resource objects provide. In this example, `ResourceVar` can be either 0 or 1 that represents two resource objects can handle a request (`Query` and `RequestMode`) from `Activity`.

Resource Allocation Traces in Figure 5.8 includes a set of locations and transitions to encode a single thread transition system for a resource allocation. The first location, `loc Activity_Query_RequestMode_REQUEST` encodes that an `Activity` sends a request of the `Query` by `RequestMode`. After sending a request, the transition system changes its location from line 1 to line 4 (`loc Activity_Query_RequestMode_BRANCH`). This transition is a

Template Parameters

```
1  template <Activity, Query, RequestMode>
```

Resource Variable Declarations

```
1  /* e.g., two resource objects that can handle Query */
2  ResourceVar: range 0..1:= 0;
```

Resource Allocation Traces

```
1  loc Activity_Query_RequestMode_REQUEST:
2    when true do {} goto Activity_Query_RequestMode_BRANCH;
3
4  loc Activity_Query_RequestMode_BRANCH:
5    when true do invisible { ResourceVar := 0; }
6    goto Activity_ResourceVar0_RequestMode_ALLOCATE;
7    when true do invisible { ResourceVar := 1; }
8    goto Activity_ResourceVar1_RequestMode_ALLOCATE;
9
10 loc Activity_ResourceVar0_RequestMode_ALLOCATE:
11  when true do invisible { }
12  goto Activity_Query_RequestMode_ALLOCATED;
13 loc Activity_ResourceVar1_RequestMode_ALLOCATE:
14  when true do invisible { }
15  goto Activity_Query_RequestMode_ALLOCATED;
16
17 loc Activity_Query_RequestMode_ALLOCATED:
18  when true do invisible { } goto /* Activity Start */;
```

Resource Allocation Events

```
1  predicates
2  (REQUEST, Activity, Query, RequestMode) =
3    THREAD@Activity_Query_RequestMode_REQUEST;
4  (ALLOCATE, Activity, ResourceVar=0, RequestMode) =
5    THREAD@Activity_ResourceVar0_RequestMode_ALLOCATE;
6  (ALLOCATE, Activity, ResourceVar=1, RequestMode) =
7    THREAD@Activity_ResourceVar1_RequestMode_ALLOCATE;
8  (ALLOCATED, Activity, Query, RequestMode) =
9    THREAD@tepObject_Query_RequestMode_ALLOCATED;
```

Figure 5.8. BIR template that handles a single resource allocation request. This example template assumes two resource objects that can handle Query without user specified resource utilization policies.

visible transition to other threads which is allowed to be interleaved. Actual request handling times are determined by complex conditions combined with schedule policies and system contexts, so these resource allocation traces can be interleaved after sending a request. The other transitions are invisible to other threads which encode the atomicity of actual resource allocation traces (reservation or assignment). Lines 4-8 encode the `ResourceVar` value setting by either 0 or 1 to keep the state of resource allocation for the `Activity`, then the transition system changes its locations to `loc Activity_ResourceVar0_RequestMode_ALLOCATE` or `loc Activity_ResourceVar1_RequestMode_ALLOCATE`, respectively. `loc Activity_ResourceVar0_RequestMode_ALLOCATE` represents that a resource object associated with 0 value has been allocated. Similarly, `loc Activity_ResourceVar1_RequestMode_ALLOCATE` indicates that a resource object associated with 1 value has been allocated. Last, as can be seen in Lines 10-15, the transition system changes its location to `loc Activity_Query_RequestMode_ALLOCATED` for starting the `Activity`.

predicates in Figure 5.8 is generated from the `Resource Allocation Traces` to recognize resource allocation events such as `REQUEST`, `ALLOCATE`, and `ALLOCATED` events during the model checking phase. For instance, $(\text{REQUEST}, \text{Activity}, \text{Query}, \text{RequestMode})$ is evaluated to be true when a `THREAD` execution reaches to the `Activity_Query_RequestMode_REQUEST` location. Then, `FLAVERS` eventually recognizes the event $(\text{REQUEST}, \text{Activity}, \text{Query}, \text{RequestMode})$ while analyzing a TFG node related to the location `Activity_Query_RequestMode_REQUEST`.

5.3.1.2 BIR Template: Single Resource Release

Figure 5.9 shows a BIR template that releases an allocated resource from an `Activity`. The template takes three parameters: `Activity`, `ReleaseQuery`, and `RequestMode`. An `Activity` is executed with an allocated resource object. `ReleaseQuery` requests which resource object is needed to be released. `RequestMode` distinguishes the allocated resource object is either reserved or assigned.

Template Parameters

```
1  template <Activity, ReleaseQuery, RequestMode>
```

Resource Release Traces

```
1  loc Activity_ReleaseQuery_RequestMode_REQUEST:
2    when ( ResourceVar == 0) do { }
3    goto Activity_ResourceVar0_ReleaseQuery_RequestMode_RELEASE;
4    when ( ResourceVar == 1) do { }
5    goto Activity_ResourceVar1_ReleaseQuery_RequestMode_RELEASE;
6
7  loc Activity_ResourceVar0_ReleaseQuery_RequestMode_RELEASE:
8    when true do invisible { }
9    goto Activity_ReleaseQuery_RequestMode_RELEASED;
10 loc Activity_ResourceVar1_ReleaseQuery_RequestMode_RELEASE:
11  when true do invisible { }
12  goto Activity_ReleaseQuery_RequestMode_RELEASED;
13
14 loc Activity_ReleaseQuery_RequestMode_RELEASED:
15  when true do { } goto /* Next Step */;
```

Resource Release Events

```
1  predicates
2  (RELEASE,Activity,ResourceVar=0,ReleaseQuery,RequestMode)=
3    THREAD@Activity_ResourceVar0_ReleaseQuery_RequestMode_RELEASE;
4  (RELEASE,Activity_ResourceVar=1_ReleaseQuery_RequestMode)=
5    THREAD@Activity_ResourceVar1_ReleaseQuery_RequestMode_RELEASE;
```

Figure 5.9. BIR template that handles a single resource release request that matches Figure 5.8.

While completing an Activity execution, an allocated resource object must be released. Resource Release Traces in Figure 5.9 represents the template traces of the release of a single resource object that matches Figure 5.8. The resource release traces follow REQUEST, RELEASE, and then RELEASED sequences. During the release phase, an allocated resource object must be released after performing an Activity. This example considers two resource objects that can be allocated and released. As can be seen in lines 2 and 4 of Resource Release Traces, the integer range variable, ResourceVar used in Figure 5.8, enforces the release of an allocated resource object. For instance, lines 2-3

show that a transition from `loc Activity_ReleaseQuery_RequestMode_REQUEST` to `loc Activity_ResourceVar0_ReleaseQuery_RequestMode_RELEASE` is only possible when `ResourceVar == 0`.

Resource Release Events in Figure 5.9 shows when resource release events are happening while traversing the Resource Release Traces. Unlike with resource allocation events, resource release events are always handled without being restricted by any policies. Therefore, the resource analysis requires that the events of actual resource release happenings as can be seen in the predicates. For instance, `(RELEASE, Activity, ResourceVar=0, ReleaseQuery, RequestMode)` event happens when the current location reaches to the `Activity_ResourceVar0_ReleaseQuery_RequestMode_RELEASE`.

5.3.1.3 BIR Template: Multiple Resource Allocations

Figure 5.10 is a BIR template that handles multiple resource allocations. This example template handles two resource allocations by taking of the following five parameters: `Activity`, `Query0`, `RequestMode0`, `Query1`, and `RequestMode1`. The `Activity` sends the two requests. Each pair of `Query0` and `RequestMode0`; and `Query1` and `RequestMode1` encodes a request.

Resource Variable Declarations in Figure 5.10 declares two boolean variables for encoding states of request handling. For instance, `Query0Handled == false` denotes that `Query0` is not handled. On the other hand, `Query0Handled == true` represents that `Query0` is handled.

Resource Allocation Traces in Figure 5.10 shows a part of a transition system that handles multiple resource allocations. As can be seen in lines 1-4, I serialize two requests to reduce the complexity of a BIR program. In this example, `Query0` is requested first and then `Query1` is requested. Even though I serialize the sequence of sending requests, it does not enforces the order of actual request handles. An order of request handle is determined through Lines 6-12 that encode the behavior of fetching requests. If both requests

Template Parameters

```
1  /* E.g., a step object sends two requests */
2  template <Activity, Query0, RequestMode0, Query1, RequestModel>
```

Resource Variable Declarations

```
1  Query0Handled: boolean;
2  Query1Handled: boolean;
```

Resource Allocation Traces

```
1  loc Activity_Query0_RequestMode0_REQUEST:
2    when true do { } goto Activity_Query1_RequestModel;
3  loc Activity_Query1_RequestModel_REQUEST:
4    when true do { } goto Activity_REQUEST_FETCH;
5
6  loc Activity_REQUEST_FETCH:
7    when (Query0Handled == false)
8      do invisible {Query0Handled := true;}
9      goto Activity_Query0_RequestMode0_BRANCH;
10   when (Query1Handled == false)
11     do invisible {Query1Handled := true;}
12     goto Activity_Query1_RequestModel1_BRANCH;
13
14  loc Activity_Query0_RequestMode0_BRANCH:
15    /* Allocate a resource object */
16  loc Activity_Query0_RequestMode0_ALLOCATED:
17    when true do invisible {} goto Activity_REQUEST_FETCH_LOOP;
18
19  loc Activity_Query1_RequestModel1_BRANCH:
20    /* Allocate a resource object */
21  loc Activity_Query1_RequestModel1_ALLOCATED:
22    when true do invisible {} goto Activity_REQUEST_FETCH_LOOP;
23
24  loc Activity_REQUEST_FETCH_LOOP:
25    when ((Query0Handled == false) || (Query1Handled == false))
26      do { } goto Activity_REQUEST_FETCH;
27    when ((Query0Handled == true) && (Query1Handled == true))
28      do { } goto /* Activity Start */;
```

Figure 5.10. BIR template that handles multiple allocation requests. This example template handles two allocation requests.

Template Parameters

```
1  template <Activity, ReleaseQuery0, RequestMode0,  
2           ReleaseQuery1, RequestModel1>
```

Resource Release Traces

```
1  loc Activity_ReleaseQuery0_RequestMode0_REQUEST:  
2    /* Release a resource allocated for Query0 */  
3  loc Activity_ReleaseQuery0_RequestMode0_RELEASED:  
4    when true do invisible { }  
5    goto Activity_ReleaseQuery1_RequestModel1_REQUEST;  
6  
7  loc Activity_ReleaseQuery1_RequestModel1_REQUEST:  
8    /* Release a resource allocated for Query1 */  
9  loc Activity_ReleaseQuery1_RequestModel1_RELEASED:  
10   when true do { } goto /* Next Step */;
```

Figure 5.11. BIR template that handles multiple release requests. This example matches with Figure 5.10

haven't been handled, the BIR statements allow nondeterministic choices of handling either `Query0` or `Query1`. After fetching a request to handle, lines 14-22 allocate a resource object for the fetched request. Each resource allocation trace, lines 15 and 20, is described in Section 5.3.1.1. After handling the fetched request, lines 24-28 determine whether there are remaining requests to be handled before starting the `Activity`. The `Activity` that sends two requests can start its execution only when the two requests have been properly handled.

The generation of resource allocation events is not different between single and multiple allocation traces. As can be seen in Figure 5.8, `REQUEST`, `ALLOCATE`, and `ALLOCATED` events are generated for each request.

5.3.1.4 BIR Template: Multiple Resource Releases

Figure 5.11 shows a BIR template that encodes multiple resource releases. In this example, an `Activity` sends two release requests of `ReleaseQuery0, RequestMode0` and `ReleaseQuery1, RequestModel1`.

Resource Release Traces in Figure 5.11 releases two allocated resource objects in Figure 5.10. As can be seen in the traces, two releases are sequentialized to reduce the complexity of the entire transition system. The serialization does not influence the analysis results because a resource manager releases resource objects immediately without being restricted by any policies. Actual resource release traces at lines 2 and 8 can be found in Figure 5.9.

Each resource release generates RELEASE event as can be seen in Figure 5.9. This example generates two RELEASE events when the transition system reaches a location that actually releases a resource object at either line 2 or 8.

5.3.1.5 BIR Template: Permission Constraint Policy

Figure 5.12 encodes the enforcement of permission constraint policies. An Activity sends a request (Query, RequestMode). The request can be handled by two candidate resource objects which are encoded by using an integer range variable, ResourceVar, in Resource Variable Declarations part. An allocation for the given request by the two resource objects is determined by two permission constraint policies: PA and PB. PA.G0 and PB.G0 are guard expressions that are evaluated to be true when the resource object encoded by the range variable 0 can handle the given request while satisfying permission constraint policies PA and PB, respectively. Similarly, PA.G1 and PB.G1 are guard expressions associated with the resource object encoded by 1.

In this example, two permission constraint policies PA and PB must be satisfied while allocating a resource object. For instance, as can be seen at line 5 in Resource Allocation Traces, a resource object 0 can handle the given request only when PA.G0 && PB.G0 == true.

As can be seen in Figure 5.12, permission constraint policies influence only guards on transitions, lines 5 and 8. Actual resource allocation and release traces can be found in Figure 5.8 and Figure 5.9, respectively.

Template Parameters

```
1  template <Activity, Query, RequestMode,  
2          PA.G0, PA.G1, PB.G0, PB.G1>
```

Resource Variable Declarations

```
1  /* e.g., two resource objects that can handle Query */  
2  ResourceVar: range 0..1:= 0;
```

Resource Allocation Traces

```
1  loc Activity_Query_RequestMode_REQUEST:  
2    when true do { } goto Activity_Query_RequestMode_BRANCH;  
3  
4  loc Activity_Query_RequestMode_BRANCH:  
5    when ((PA.G0 && PB.G0) == true)  
6      do invisible { ResourceVar := 0; }  
7      goto Activity_ResourceVar0_RequestMode_ALLOCATE;  
8    when ((PA.G1 && PB.G1) == true)  
9      do invisible { ResourceVar := 1; }  
10     goto Activity_ResourceVar1_RequestMode_ALLOCATE;  
11  
12  /* Allocate a resource object */  
13  
14  loc Activity_Query_RequestMode_ALLOCATED:  
15    when true do invisible { } goto /* Activity Start */;
```

Figure 5.12. BIR template that handles multiple permission constraint policies. This example template encodes two permission constraint policies that restrict the possible allocation of two resource objects for a given request.

5.3.1.6 BIR Template: Priority Conflict Resolution Policy

Figure 5.13 is an example of a BIR template that encodes a priority conflict resolution policy. In this example, enforcing a set of PA and PB permission constraint policies has a higher priority than enforcing only PB permission constraint policy. A request (Query, RequestMode) from an Activity is restricted by this priority conflict resolution policy. This example template considers two resource objects as can be seen in Resource Variable Declarations.

Template Parameters

```
1  template <Activity, Query, RequestMode,  
2      PA.G0, PA.G1, PB.G0, PB.G1>
```

Resource Variable Declarations

```
1  /* e.g., two resource objects that can handle Query */  
2  ResourceVar: range 0..1:= 0;
```

Resource Allocation Traces

```
1  loc Activity_Query_RequestMode_REQUEST:  
2      when true do { }  
3      goto Activity_Query_RequestMode_BRANCH;  
4  
5  loc Activity_Query_RequestMode_BRANCH:  
6  when ((PA.G0 && PB.G0)==true)  
7      || (((PA.G1 && PB.G1)==false)  
8          && ((PA.G0 && PB.G0)==false))  
9          && (PB.G0==true))  
10     do invisible { ResourceVar := 0; }  
11     goto Activity_ResourceVar0_RequestMode;  
12 when ((PA.G1 && PB.G1)==true)  
13     || (((PA.G0 && PB.G0)==false)  
14         && ((PA.G1 && PB.G1)==false))  
15         && (PB.G1==true))  
16     do invisible { ResourceVar := 1; }  
17     goto Activity_ResourceVar1_RequestMode;  
18  
19 /* Allocate a resource object */  
20  
21 loc Activity_Query_RequestMode_ALLOCATED:  
22     when true do invisible { } goto /* Activity Start */;
```

Figure 5.13. This example BIR template encodes a priority conflict resolution policy. A set of permission constraint policies of PA and PB has higher priority than a set of permission constraint policies of PB.

Resource Allocation Traces in Figure 5.13 shows the transitions for the enforcement of a priority conflict resolution policy. For instance, line 6 shows that a resource object 0 can handle the given request if the high prioritized a set of permission constraint policies of PA and PB are satisfied, $PA.G0 \ \&\& \ PB.G1 == true$. In this example template, the priority

conflict resolution policy enforces only the PB permission constraint policy when there are no candidate resource objects that satisfy both the PA and PB permission constraint policies. Lines 7-8, `((PA.G1 && PB.G1) == false) && ((PA.G0 && PB.G0) == false)`, represents that both resource objects 0 and 1 are not able to satisfy PA and PB together. Then, line 9 encodes that enforcing only PB permission constraint policy, `PB.G0 == true`.

5.3.1.7 BIR Template: Case Conflict Resolution Policy

Figure 5.14 shows a BIR template that encodes a case conflict resolution policy. In this example, a conflict condition of the case conflict resolution policy happens when PA permission constraint policy is satisfied, but the PB permission constraint policy is not satisfied. When this conflict condition happens, the case conflict resolution policy enforces only PB. A request (Query, RequestMode) from the Activity is restricted by this case conflict resolution policy. As can be seen in Resource Variable Declarations, this example template considers two resource objects as candidates to handle the given request.

Resource Allocation Traces is a template transition system that enforces the case conflict resolution policy. For instance, if no conflict happens such as line 6, `(PA.G0 && PB.G0) == true`, 0 resource object can handle the given request. However, if a conflict happens, the case conflict resolution policy allows the enforcement of only PB. Lines 7-8, `((PA.G1 && PB.G1) == false) && (PA.G0 == true && PB.G0 == false)`, encode the specific case of a conflict condition. Given the satisfaction of the condition, line 9 allows enforcing only PB permission constraint policy.

5.3.2 Trace Flow Graph Encoding Resource Utilization

After generating a BIR program, TFG Translator in Figure 5.7 translates the BIR program to a TFG for FLAVERS. FLAVERS/Little-JIL already provides the BIR to TFG translator. Therefore, this section describes some examples to illustrate how the BIR templates in Section 5.3.1 are translated to TFGs. The generated TFG varies depending on various optimization techniques provided by FLAVERS/Little-JIL such as the variable

Template Parameters

```
1  template <Activity, Query, RequestMode,  
2      PA.G0, PA.G1, PB.G0, PB.G1>
```

Resource Variable Declarations

```
1  /* e.g., two resource objects that can handle Query */  
2  ResourceVar: range 0..1:= 0;
```

Resource Allocation Traces

```
1  loc Activity_Query_RequestMode_REQUEST:  
2      when true do { }  
3      goto Activity_Query_RequestMode_BRANCH;  
4  
5  loc Activity_Query_RequestMode_BRANCH:  
6      when ((PA.G0 && PB.G0)==true)  
7          || (((PA.G1 && PB.G1)==false)  
8              && (PA.G0==true && PB.G0==false))  
9              && (PB.G0==true))  
10         do invisible { ResourceVar := 0; }  
11         goto Activity_ResourceVar0_RequestMode;  
12         when ((PA.G1 && PB.G1)==true)  
13             || (((PA.G0 && PB.G0)==false)  
14                 && (PA.G1==true && PB.G1==false))  
15                 && (PB.G1==true))  
16         do invisible { ResourceVar := 1; }  
17         goto Activity_ResourceVar1_RequestMode;  
18  
19     /* Allocate a resource object */  
20  
21     loc Activity_Query_RequestMode_ALLOCATED:  
22         when true do invisible { } goto /* Activity Start */;
```

Figure 5.14. This example template encodes a case conflict resolution policy. A conflict condition is defined when a permission constraint policy PA is satisfied, but PB is not satisfied. This specific conflict case is resolved by enforcing only PB.

inlining heuristic, partial order reduction, and other optimization algorithms. This section, however, shows an intuitive translation approach to better explain how a BIR program with resource utilization is represented by using a TFG.

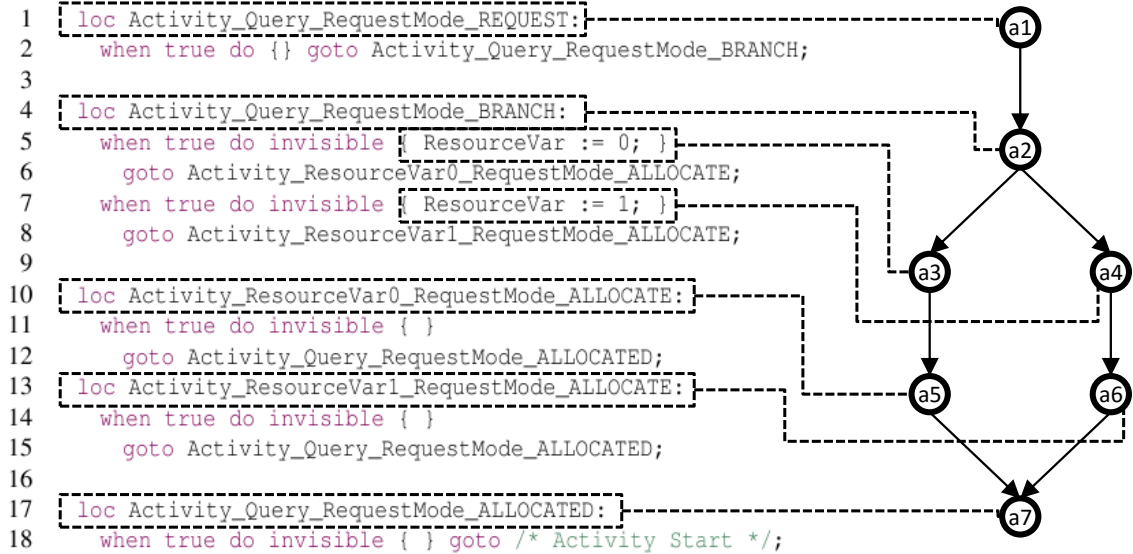

Figure 5.15. BIR to TFG translation: resource allocation BIR template in Figure 5.8.

Figure 5.15 shows how the BIR template of resource allocation transitions in Figure 5.8 is translated into a TFG. Each location that encodes states of resource allocation in the BIR template is mapped to a unique node in the TFG. In addition, each resource variable assignment action (e.g., `ResourceVar := 0`) in the BIR template is also mapped to a unique node in the TFG because the assignment changes a system state. In this example, either `ResourceVar := 0` or `ResourceVar := 1` restricts the feasible resource release traces (see Figure 5.9).

Figure 5.16 illustrates a transition from the BIR template of resource release transitions in Figure 5.9 to a TFG. In addition to the mapping from BIR locations to TFG nodes, each guard condition in the BIR template is also mapped to a unique node in the TFG. For example, `ResourceVar == 0` and `ResourceVar == 1` are mapped to two different TFG nodes. The evaluation of these guard expressions determines resource utilization traces after the evaluation. Therefore, the guard expressions associated with resource utilization must be included in a TFG for analyzing resource utilization. For example, if `ResourceVar := 0`

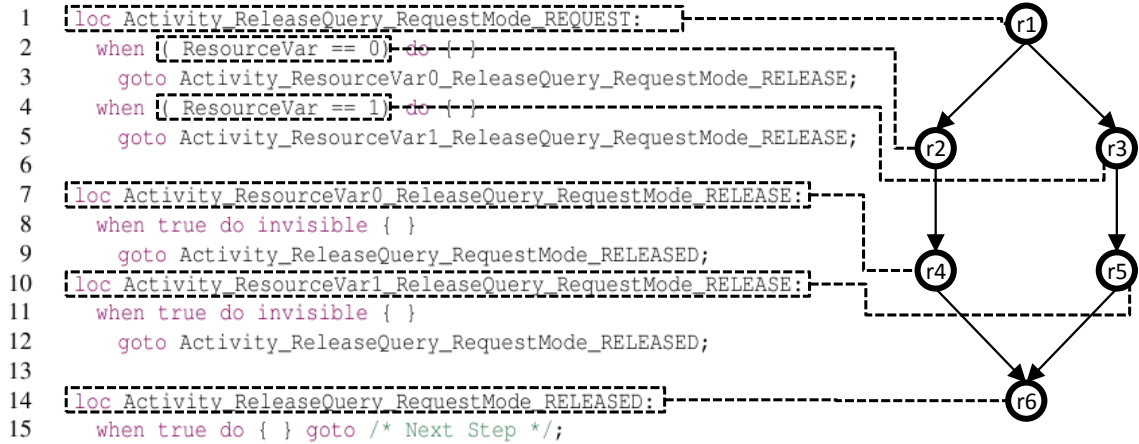

Figure 5.16. BIR to TFG translation: resource release BIR template in Figure 5.9.

in Figure 5.15 is traversed, traces after `ResourceVar == 1` in Figure 5.16 must be excluded from analysis space.

The other templates in Section 5.3.1 are translated into a TFG in a similar way. Specification of resource utilization policies often generates complex guard expressions in a BIR program; however, translation from a guard expression in a BIR program to a TFG is straightforward.

5.3.3 Resource Constraint Finite State Machine

A TFG is a conservative representation that includes infeasible traces. For instance, assuming the TFG in Figure 5.15 and the TFG in Figure 5.16 are associated with the same activity, then the resource utilization trace, $a1 \rightarrow a2 \rightarrow a3 \rightarrow a5 \rightarrow a7 \rightarrow \dots \rightarrow r1 \rightarrow r3 \rightarrow r5 \rightarrow r6$, is an infeasible trace because `ResourceVar := 0` at `a3` is executed in this example trace, but `ResourceVar == 1` at `r3` is evaluated to be false. These infeasible traces in a TFG are excluded from the analysis searching space in FLAVERS by using a set of constraint finite state machines. Constraint FSM Translator in Figure 5.7 generates constraint FSMs to exclude infeasible resource utilization traces in a BIR program. FLAVERS/Little-JIL provides the Constraint FSM Translator component, but I extend

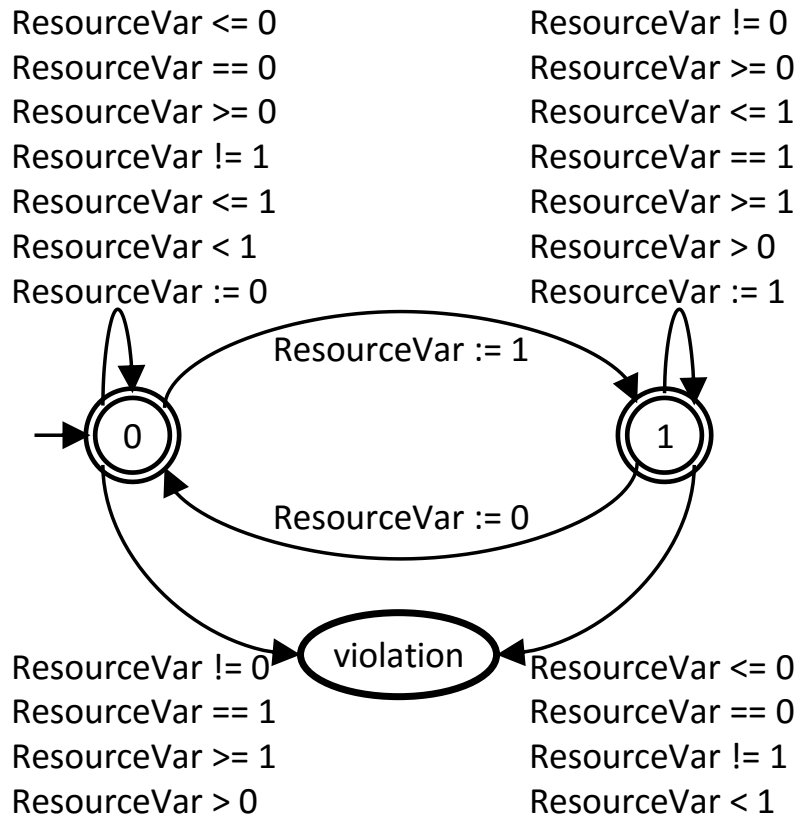

Figure 5.17. Constraint FSM associated with the integer range variable (ResourceVar: range 0..1) to reference two resource objects.

the component to enforce resource capacity constraints. This section focuses on describing constraint FSMs related to excluding infeasible resource utilization traces and enforcing resource capacity constraints.

Figure 5.17 shows a constraint FSM that restricts valid expressions at each state related to ResourceVar: range 0..1 integer range variable such as ResourceVar <= 0, ResourceVar == 0, and other expressions. The constraint FSM has three states: 0, 1, and violation. 0 and 1 states represent the value of ResourceVar variables. State violation represents a trap which means all expressions are invalid at the violation state. This constraint FSM is used to enforce resource allocation-release matching and resource utilization policies. For instance, a trace $a_1 \rightarrow a_2 \rightarrow a_3 \rightarrow a_5 \rightarrow a_7 \rightarrow \dots \rightarrow r_1 \rightarrow r_3 \rightarrow r_5 \rightarrow r_6$ in Figure 5.15 and Figure 5.16 is determined to be an infeasible trace. a_3

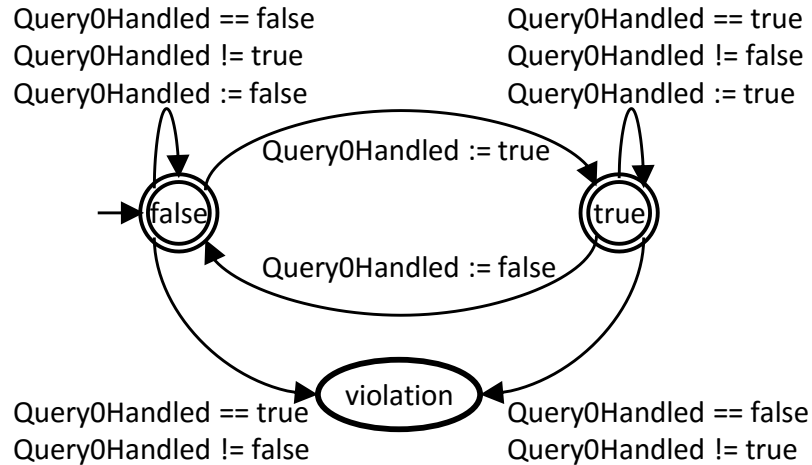

Figure 5.18. Constraint FSM that excludes infeasible traces of handling multiple requests from an activity.

generates `ResourceVar := 0` event, so the event triggers staying in 0 state. However, `r3` generates `ResourceVar == 1`, then the event triggers the transition from 0 to violation state. FLAVERS uses the `violation` state to determine whether a trace is infeasible or not. Concerning resource utilization policies, as can be seen in Figure 5.12, 5.13, and 5.14, resource utilization policies are encoded by using guard expressions in a BIR program. Thus, constraint FSMs similar to Figure 5.17 is generated to enforce the specified resource utilization policies.

Figure 5.18 shows a constraint FSM that enforces valid sequences of handling multiple requests from an activity. The constraint FSM has three states: `false`, `true`, and `violation`. `false` and `true` states represent the value of the `Query0Handled` boolean variable. As can be seen in Figure 5.10, `Query0Handled` variable is used to keep distinguishing whether the `Query0` request is handled or not while handling multiple requests. For instance, if `Query0Handled` is updated as `true` at the line 8 in Figure 5.10, the constraint FSM changes its state from `false` to `true`. Then, a trace that revisits the line 8 is infeasible because `Query0Handled == false` at line 7 changes the constraint FSM's state from `true` to

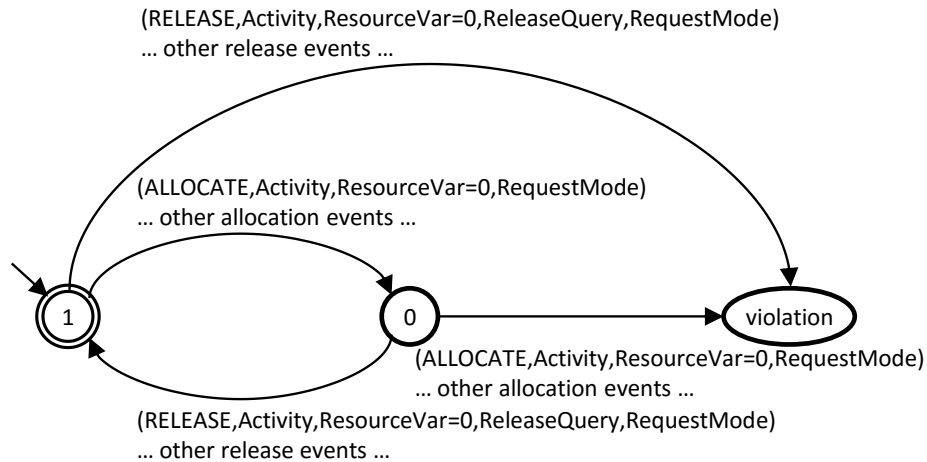

Figure 5.19. Template constraint FSM that excludes infeasible resource utilization traces that violate resource capacity constraints.

false. Similar constraint FSMs are generated to handle each request when an activity requires multiple resources.

A resource object has capacity limits for handling multiple reservation and assignment requests and spends a certain amount of effort while providing capabilities. This capacity constraint of a resource object is encoded by using a resource capacity constraint FSM. To generate the constraint FSM, `Constraint FSM Translator` takes a specification of resource characteristics and a BIR program. The capacity constraint is specified in a specification of resource characteristics (see Section 3.1). A BIR program includes the information of resource allocation and release events. The creation of a resource constraint FSM is straightforward, but it assumes static capacity and effort-needed values because FLAVERS supports finite state verification.

Figure 5.19 shows a template of a resource capacity constraint FSM assuming a resource object has the capacity limit of 1 for the `RequestMode` of either reservation or assignment, and spends 1 amount of effort in providing a requested capability from the `Activity`. 1 and 0 states represent the remaining capacity of a resource object. `violation` state is a trap state to test the feasibility of allocation and release event traces. Transitions between the

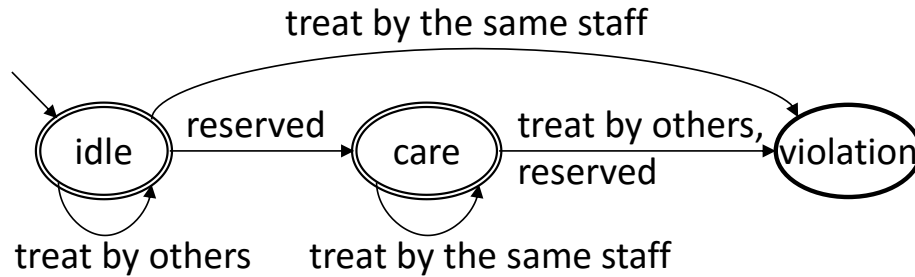

Figure 5.20. This property FSM encodes the same staff (e.g., MD and RN) property. The `idle` and `care` states are accepting states. The `violation` state is a trap state.

states are derived from resource allocation and release events in an input BIR program. The constraint FSM encodes that a resource object represented by `ResourceVar=0` is allowed to be allocated only once. For instance, the constraint FSM will reach the `violation` state when the resource object is allocated twice. In other cases, the FSM will stay in either 1 or 0 state.

5.3.4 Resource Property Finite State Machine

To verify a property FSM related to resource utilization requires a mechanism to bind events in the property FSM with resource utilization events in a system such as resource allocation and release events (see Section 5.2.2). FLAVERS/Little-JIL provides a mechanism to bind events in a property FSM with Little-JIL events such as activity started/completed, artifact defined/used, and other events. However, the existing approach does not support new resource events. This section describes my approach to bind events in a property FSM with resource allocation and release events.

Figure 5.20 shows the same staff (e.g., MD and RN) property. The property FSM contains the states that a given staff resource object can be in. The `idle` state means that the staff is not in charge of caring for a patient. The `reserved` event indicates that the staff is reserved to care for the patient. After the staff is reserved to care for the patient, the property FSM allows treating the patient by only the same staff (`treat by the same staff` event).

If the patient is cared for by another staff, the property FSM reaches the `violation` state which indicates a violation of the same staff property.

For FLAVERS verification, the events in the property FSM (e.g., `treat` by the same staff) are matched to the nodes in the TFG that represent resource utilization such as resource allocations or releases. To select a set of resource utilization events by users, I provide the following six resource event templates:

- `request_reserve(resource object, XPath expression)`: a set of resource reservation request events that are associated with the requests of a `resource object` from activities pointed by an `XPath expression`.
- `request_assign(resource object, XPath expression)`: a set of resource assignment request events that are associated with the requests of a `resource object` from activities pointed by an `XPath expression`.
- `reserve(resource object, XPath expression)`: a set of resource reservation events that are associated with the reservations of a `resource object` to perform activities pointed by an `XPath expression`.
- `assign(resource object, XPath expression)`: a set of resource assignment events that are associated with the assignments of a `resource object` to perform activities pointed by an `XPath expression`.
- `release_reserved(resource object, XPath expression)`: a set of resource release events that are associated with the releases of a reserved `resource object` from activities pointed by an `XPath expression`.
- `release_assigned(resource object, XPath expression)`: a set of resource release events that are associated with the releases of a assigned `resource object` from activities pointed by an `XPath expression`.

For instance, Figure 5.21 shows an example of resource event binding for the property FSM in Figure 5.20. The `reserved` event is associated with a set of resource reservation events by `reserve(md0, /ED//InsideED[1])`. The `reserve(md0, /ED//InsideED[1])`

Event name	Resource event binding
reserved	reserve(md0, /ED//InsideED[1])
treat by the same staff	assign(md0, /ED//InsideED[1]**)
treat by others	assign(md1, /ED//InsideED[1]**), assign(md2, /ED//InsideED[1]**)

Figure 5.21. An example of resource event binding for the same MD property assuming three MD resource objects (md0, md1, and md2). The event names are declared in Figure 5.20

represent a resource reservation event that happens when the md0 is reserved to perform the InsideED activity to care for the first patient. Figure 5.22 shows which activity is pointed by /ED//InsideED[1]. After the reservation, only the same md0 is allowed to care for the first patient. Therefore, the treat by the same staff event is mapped to a set of resource assignment events by assign(md0, /ED//InsideED[1]**). As can be seen in Figure 5.22, the /ED//InsideED[1]** selects a set of activities which cares for the first patient under the InsideED activity. The treat by others event is mapped to a set of resource assignment events associated with md1 and md2. Similarly, users can bind RN resource objects to verify the same RN property.

5.3.5 Reachability Analysis for Resource Utilization

Even though property FSM verifications using FLAVERS is applicable to verify a variety kinds of resource related properties, system analysts require additional analyses to achieve sound resource utilization which are free from resource leaks, resource deadlocks, and conflicts between policies of resource utilization. FLAVERS uses the state propagation algorithm to verify a property FSM with a TFG and a set of constraint FSMs. For instance, while FLAVERS propagates states, a trace that causes a resource deadlock is deleted from analysis searching space because the trace violates the resource capacity constraints. To be specific, if both two concurrent activities, A and B, require two resource objects, r0 and r1, this system has a resource deadlock problem assuming both r0 and r1 are

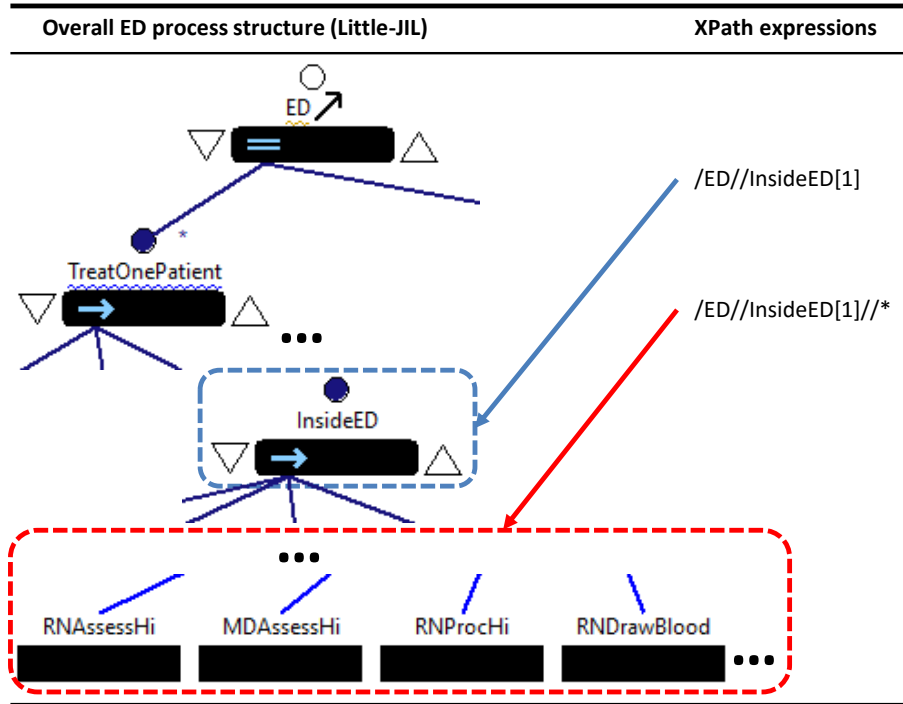

Figure 5.22. Overall ED process structure of Little-JIL and XPath expressions.

allowed to be assigned once at most. For example, if r_0 resource object is assigned to A activity and r_1 resource object is assigned to B activity, A waits to acquire r_1 and B waits to acquire r_0 . While FLAVERS analyzes the system, for instance, all traces after $\text{assign } r_0 \text{ to } A \rightarrow \text{assign } r_1 \text{ to } B$ are deleted because they violate the resource capacity constraints. Therefore, the problem traces are not captured at the end of state propagation when FLAVERS tests the property satisfaction. I utilize a node-tuple graph of FLAVERS to facilitate reachability analysis for the verification of the soundness of resource utilization: free from resource leaks, resource deadlocks, and conflicts between policies.

FLAVERS/Little-JIL generates a node-tuple graph for purposes of detailed examination of analysis. A node-tuple graph is a representation of how FLAVERS propagates states associated with a property FSM and constraint FSMS while traversing a given TFG. Therefore, the node-tuple graph presents all the possible state changes of a system. Each vertex in the graph represents a unique state combination in a property FSM, a set of constraint FSMS,

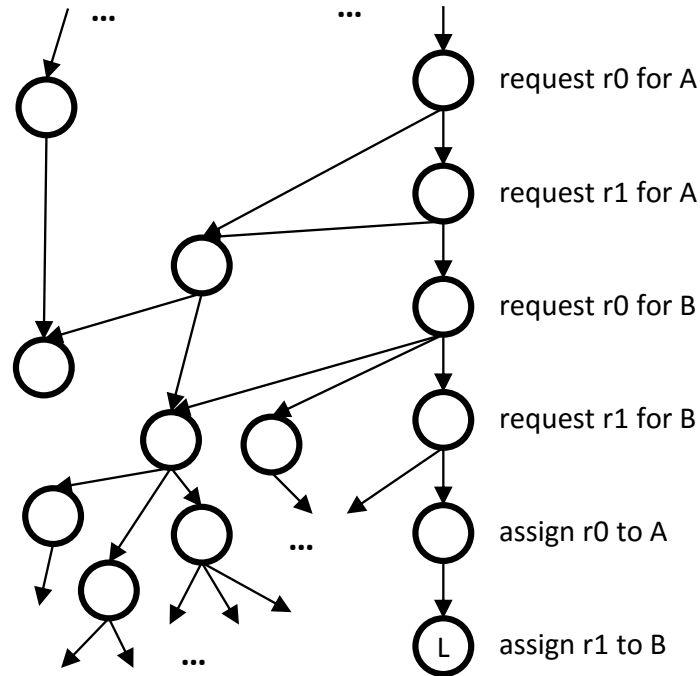

Figure 5.23. A node-tuple graph example: each vertex is associated with a unique state combination in a property FSM, a set of constraint FSMs, and a TFG node. Edges represent feasible state transitions.

and a TFG node. Edges in the graph represent feasible state transitions. Given the node-tuple graph, I associate resource events with relevant vertices in the graph. Given the association, I provide a reachability analysis for a pair (e_1, e_2) of two resource events representing e_1 must be followed by e_2 . Resource leaks can be analyzed by using a pair of allocation and release events. For instance, if the md_0 resource object is assigned to the activity $MDckCT$, the release event of md_0 from $MDckCT$ must be followed. Resource deadlocks and conflicts between policies can be found by a pair of resource request and allocation events because both problems cause failures in resource allocation after requesting resources.

Figure 5.23 shows an example of a node-tuple graph. The trace to L vertex in Figure 5.23 is not reached to the end node of the node-tuple graph. This means that all the following states from the L state is infeasible. This kind of partially feasible trace is captured in a node-tuple graph that allows the analysis of problematic resource utilization. As can be seen in

Figure 5.23, all the resource request events are not followed by related resource assignment events (see `request r1 for A` is not followed by `assign r1 to A`). The problem trace can occur for various reasons such as resource deadlocks or conflict between policies. A counterexample trace that violates the matching between request and assign events helps users figure out the reason for the problem trace.

CHAPTER 6

EVALUATION

I evaluate my framework of resource utilization policy specification and analysis through a case study applying the framework to a patient care system in a hospital ED. The evaluation aims to test the following main hypothesis:

Main hypothesis: Separated resource utilization policy concerns in the specification and analysis framework helps design sound resource management decisions in human-intensive systems.

This main hypothesis of my framework will be tested through several decomposed secondary hypotheses (described in the remaining sections) related to specification, process- and resource-aware discrete-event simulation and process- and resource-aware finite state verification. My evaluations show feasibility and effectiveness of my framework of resource utilization policy specification and analysis.

6.1 Resource Modeling

Secondary hypothesis 1: Separation of resource utilization policy concerns allows specifying complex resource management constraints in a manageable manner.

A real-world hospital ED governs diverse and complex resource utilization policies to achieve high quality patient care. Therefore, proper specification of the hospital resource utilization policies is essential to reflect important real-world resource utilization policies. In addition, flexible changes in resource utilization policies by simple modification of specifications are required to expedite the evaluation of the effects of diverse alternatives of

resource utilization policies. Through my evaluations, I test the above secondary hypothesis through qualitative comparisons with other approaches. In addition, Section 6.2 also demonstrates the flexibility of my resource modeling approach through the evaluations of various staffing options.

6.1.1 Patient Care Model Comparison

Patient care processes in a hospital ED have been widely studied by using analytical approaches [13, 23, 35]. Many analytical approaches address scheduling problems in a hospital ED. Green et al. [23] develop a method to create staffing with the consideration of varying patient arrival rates, focusing on the lag between patient arrival and start of treatment by using queuing models. Cochran et al. [13] provide a method for the capacity planning of beds and staff resources. Li et al. [35] develop an analytical framework and suggest redistributing resources to mitigate bottlenecks. These analytical approaches are attractive because of closed form expressions can be relatively easy to calculate; however, most of these studies simplify ED care processes considerably without incorporating key hospital resource utilization policies such as the same doctor policy.

To compensate the limitations of creating reasonably complete and detailed analytical models, discrete-event simulations are widely used to analyze the patient care processes [8, 69, 76]. Wang et al. [69] use a simulation model to identify potential changes to reduce patients' length of stay such as combining registration with triage, adding float nurses, and so on. Zeng et al. [76] use a simulation model to study the ED of a community hospital and suggest that a team nursing policy can significantly improve ED efficiency. Brenner et al. [8] use simulations to identify bottlenecks and investigate the optimal numbers of staff and equipment resources. In contrast to my work, these simulations still oversimplify hospital resource utilization policies. For instance, none of these simulation studies include the handoff policy.

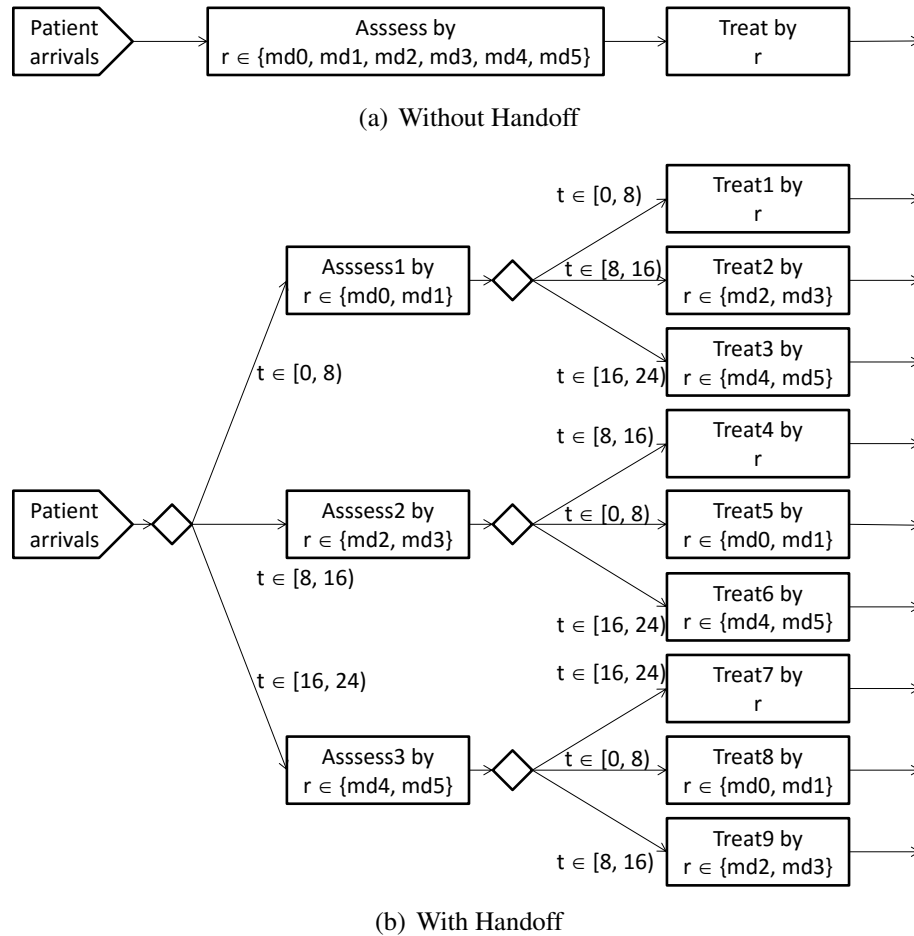

Figure 6.1. Partial patient care process model by using Arena which incorporates six MDs working in three separate 8-hour shifts. (a) The shift and same doctor policies are included. (b) The shift, same doctor, and handoff policies are included.

Arena discrete-event simulation tool [54] is widely used to study patient care processes in a hospital ED [3, 6, 20]. Figure 6.1 presents how the handoff policy increases complexity in a patient care model using Arena. I built the model based on advice from a professor who teaches Arena in his class and referenced an ED model in [6]. Arena uses a resource module to specify resources in a system. Resources can be grouped together as a set of resources (see $\{md0, md1, md2, md3, md4, md5\}$ in Figure 6.1). These resources are allocated and released by using process modules (rectangular box in Figure 6.1). At first, to support the same doctor policy, for instance, I use an attribute named r associated with a patient

arrival in Figure 6.1(a). `Assess` activity is performed by a resource `r` which is one of the six resources. To enforce the `Treat` activity to be performed by the same doctor who performs the `Assess` activity, I specifically allocate the `r` resource to perform the `Treat` activity. Second, I use a schedule module to specify the shift policy. A resource has a capacity which determines the number of resource units. The capacity can be varied over a simulation run by using a schedule module. A schedule module adjusts the capacity of a resource for a given period of time. By using a schedule model, I can specify three separate shifts for each resource (for instance, `md0` and `md1` work from 0 to 8 hours, `md2` and `md3` work from 8 to 16 hours, and `md4` and `md5` work from 16 to 24 hours a day). However, if availability depends on the resource's own characteristics, the resource model of Arena seems unsuitable to specify this dependency because the resource module hasn't been abstracted to characterize a resource in general. For example, a doctor working in the fast-track cannot care for a patient in the main-track. In addition, if the doctor moves to the main-track to help resolve a crowded condition in the main-track, the doctor then becomes available to care for patients only in the main-track. Last, Arena has difficulties specifying a conflict resolution among multiple resource utilization policies. As can be seen in Figure 6.1(b), handoff logic is embedded in the process model. For instance, when a patient arrives at 7.9 time ($t \in [0, 8)$), `Assess1` is performed and `r` associated with a patient arrival is used to enforce the same doctor policy. After `Assess1`, if the time becomes 8.1, the patient treated by `r` resource must be handed over to another doctor. Then, `Treat2` is executed to handle this handoff. In addition, Arena supports schedule policies by adjusting patient queues that are associated with each process module; however, if an administrator wants to change the constraints from sickest-first to heuristic-based, entire patient queues have to be changed to support this single change.

Many other simulation tools are used to study patient care processes such as SAS Simulation Studio [56], SimEvents/Matlab [40], FlexSim [22], Simio [60], and ProModel [49]. In general, these simulation systems specify a resource as stationary or mobile resources

which are embedded in their process model. None of these simulation systems abstract out resource management concerns which facilitates flexible support of complex resource utilization policies as I did.

Static analysis techniques are also widely used in many application domains. However, to the best of my knowledge, none of this previous work has been applied to study patient care processes in a hospital ED. Li et al. [34] provide a resource constraints analysis approach for process specifications. They classify resources into two types: shared and private resources. They detect a potential resource contention by using resource dependency and reachability information. Wang et al. [68] introduce resource-constrained process model as well as a resource capacity analysis approach. They formally define resources and their participation such as resource consumption for starting a task and resource production after executing a task. In contrast to my approach, these previous studies have difficulties in specifying and analyzing complex resource utilization policies. These prior static analyses have focused on only a specific resource utilization problem such as resource contention and capacity limits based on relatively simplified resource models.

6.2 Process- and Resource-Aware Discrete-Event Simulation

Secondary hypothesis 2: A separated resource management component enables analyses of detailed behaviors of resource participants.

Resource utilization policies are related to other components of a system such as activities, artifacts, resources and even other resource utilization policies. Therefore, even small changes in a resource utilization policy may greatly influence executions of the entire system. Because of the influence of a resource utilization policy, domain experts require sufficient information to make an efficient and effective resource utilization policy. My evaluations test whether the detailed simulation traces of resource utilization provides sufficient information to answer my domain expert's questions.

This section describes how I used my simulation-based scheduling approach to study the effects of different staffing levels and policies on the operational characteristics of my example ED. For this work, I used the process model presented in Chapter 4, and the resource specifications presented in Chapter 3. The ED model includes 2 triage nurses, 5 clerks, 48 beds, 2 x-ray rooms and 4 CT rooms. This ED resource distribution was based on Baystate Medical Center data. I executed enough simulation replications to obtain 95% confidence intervals and a half-width within 2% of the mean of staff utilizations. For each replication, I simulated 72 hours of ED operations, using only the output of the middle 24-hours in my analysis to ensure that each replication had adequate amounts of warm-up and wind-down times, but that these times did not influence my mean estimates. I used Amazon EC2 to create a virtual server (c4.8xlarge type) to run my simulations. The server instance took about 41 minutes for 100 simulation replications.

In these simulations I measured utilization rates for MDs and RNs, the average patient LoS, the ED contribution margin, and the impact of staff shift scheduling on the number of patient handoffs. I defined LoS as the time from a patient's arrival to departure, and ED contribution margin as the total revenue (using Medicare reimbursement levels) derived from treating all patients in the simulated 24-hour period minus costs for staffing, supplies, and medications.

I begin by presenting results of the staffing demands algorithm, which yields the number of MDs and RNs needed in each hour of the day to ensure that utilization falls in a pre-specified range. I tested this algorithm for various combinations of MD and RN utilization levels suggested by my domain expert. Figure 6.2 shows some example results where I have assumed that staffing levels can change every hour as needed, allowing shifts to be as short as one hour, but assuring that the number of MDs and RNs is equal exactly to the results produced by the staffing demands algorithm.

Figure 6.3 compares LoS for a number of different combinations of staff utilization levels. The figure uses a gray band to indicate average LoS that lies between 130%-140% of

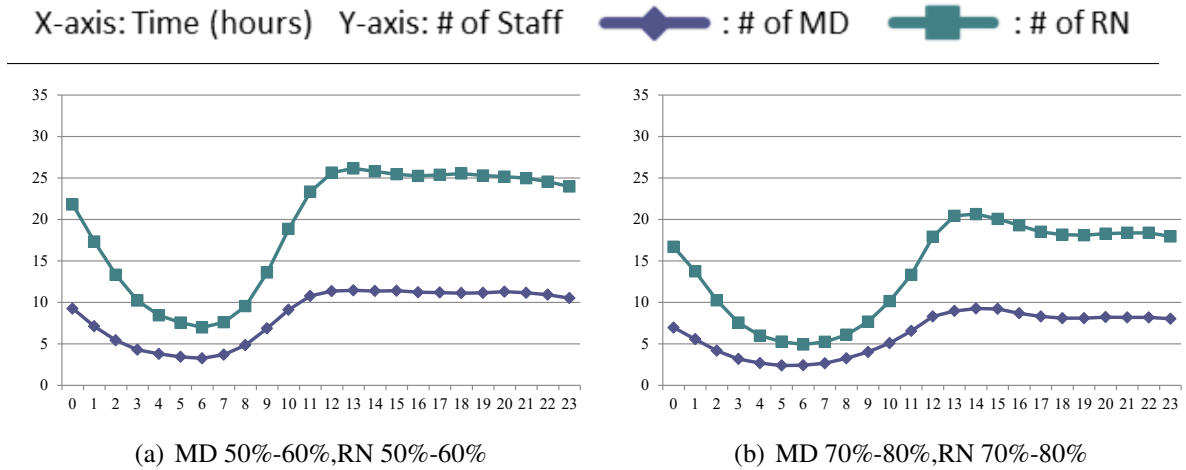

Figure 6.2. MD and RN staffing demands curves using the staffing demands algorithm in Figure 4.5. For example, (a) is MD and RN staffing demands curves when MD's and RN's lower and upper utilization limits are set as 50% and 60%, respectively. I omitted other combinations of resource utilization ranges for exposition.

the minimum possible value (116 minutes). The average LoS range as determined by my domain expert's expertise is used as an objective for staff scheduling. I define the minimum average LoS based on ignoring all wait times caused by resource contention problems (i.e., assuming infinite supply of resources). The calculation of the minimum average LoS is straightforward by using the static process structure and steps' execution times of my ED model. The Figure shows that four staffing solutions, MD(50%–60%) RN(70%–80%), MD(60%–70%) RN(70%–80%), MD(70%–80%) RN(50%–60%), and MD(70%–80%) RN(60%–70%), satisfy that LoS objective. Among them, MD(70%–80%) RN(60%–70%) staffing maximizes the contribution margin at 55,113 USD/day.

6.2.1 Impact of Shift Length and Overlap

To consider the impact of shift length and overlap, I ran simulations that allowed RN shift lengths to be 6, 8 or 12 hours, and compared the effect of prohibiting shifts to overlap (i.e. start and stop at the same time) to the case where overlap is allowed. Figure 6.4 shows RN staffing solutions output from the ILP-based staffing algorithm in Section 4.3.1.2, compared to results generated by the staffing demands algorithm. Note that the results

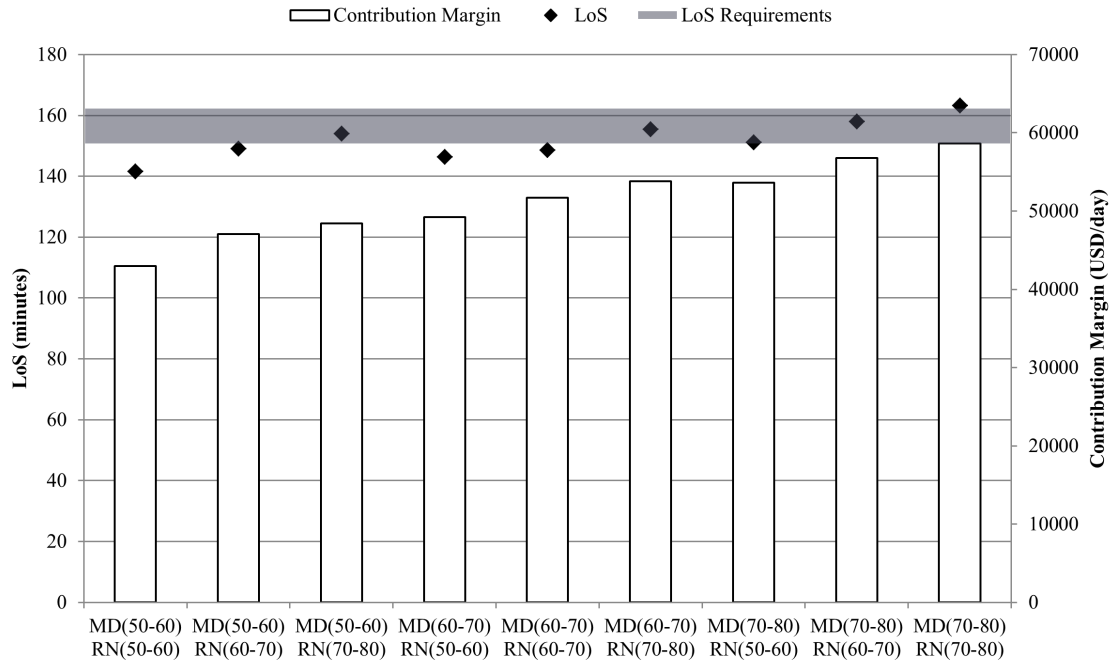

Figure 6.3. Simulation results of patient’s LoS, contribution margin according to each utilization boundary. LoS Requirements is the LoS objective, so that four staffing, MD(50-60) RN(70-80), MD(60-70) RN(70-80), MD(70-80) RN(50-60) and MD(70-80) RN(60-70) satisfy it.

produced by the ILP for a given shift length and overlap constraint are always equal to or higher than the staffing demands curve.

Figure 6.4(a) and Figure 6.4(c) show that 12-hour shift lengths cannot cover staffing demands as closely as 8-hour shift lengths, and comparing Figure 6.4(c) to Figure 6.4(a), shows that overlapping shifts cover the staffing demands curves more closely than non-overlapping shifts. Figure 6.4(d) shows that staffing with overlapped shifts of 6, 8 or 12-hour lengths (flexible staffing) is almost indistinguishable from the staffing demands curve itself.

Figure 6.5 shows that average LoS for the different shift length and overlap combinations does not differ significantly, although Figure 6.5 shows staffing based on 12-hour shift lengths, with or without overlapped shifts, creates shorter LoS than 6-hour and 8-hour staffing. This makes intuitive sense because 12-hour shifts allow more RNs to be scheduled in more hours (see Figure 6.4(c) and Figure 6.4(a)), reducing RN contention and thus

X-axis: Time (hours) Y-axis: # of RN  : Staffing Demands  : Staffing

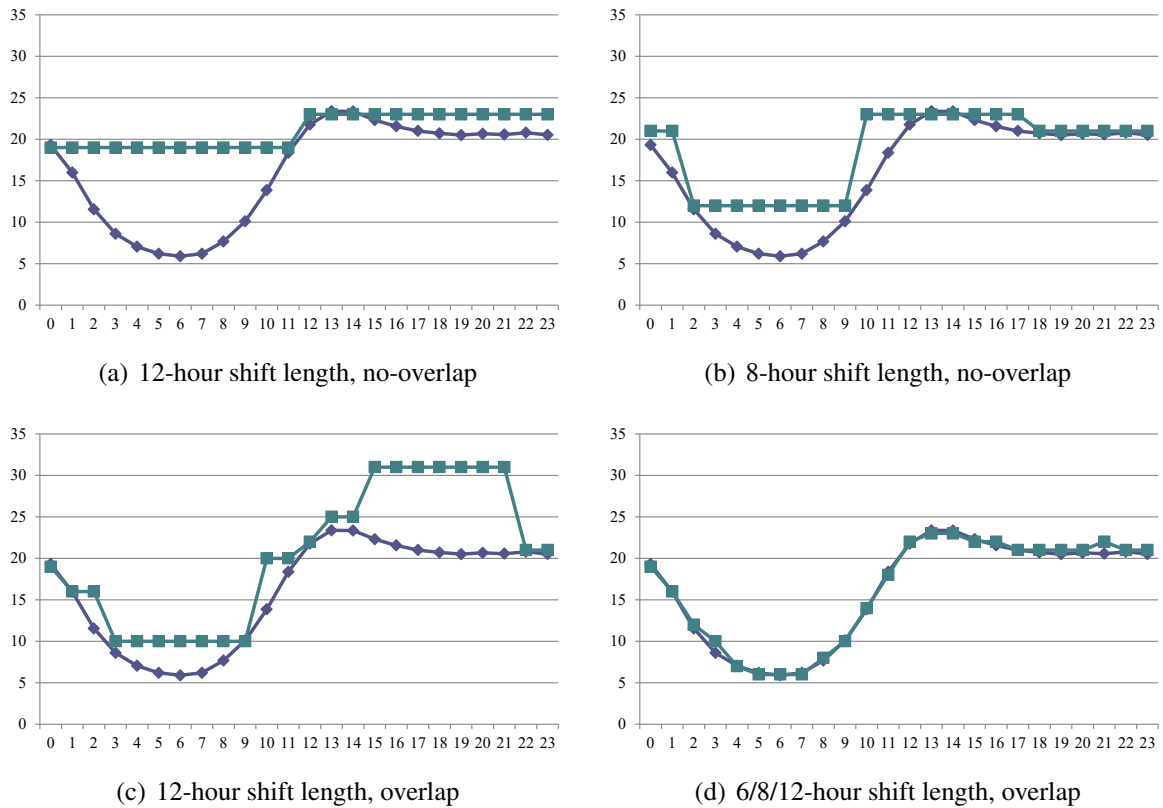

Figure 6.4. ILP solutions of various RN staffing patterns: (a) and (C) 12-hour shifts disallowing and allowing shift overlap, respectively; (b) 8-hour shift disallowing shift overlap; and (d) allowing for combinations of overlapping 6-, 8-, and 12-hour shifts. Staff salaries (USD/day): (a) 27,720, (b) 24,640, (c) 27,060 and (d) 21,560. I omitted other combinations such as 6-hour shifts allowing and disallowing shift overlap for exposition.

reducing patient waiting time. In general, staffing without overlap creates lower LoS than staffing with overlap. Comparing 1-hour and flexible staffing options in Figure 6.5, flexible staffing results in longer LoS than 1-hour staffing. This long LoS is caused by the same MD and RN: the patient will more frequently have to wait to be attended by the same MD and RN.

Figure 6.6 compares the number of handoffs among various staffing options. Shorter shifts (especially one-hour shifts) necessitate more handoffs, which should be minimized, as my domain expert believes they lead to increased errors. Indeed, Figure 6.6 shows that

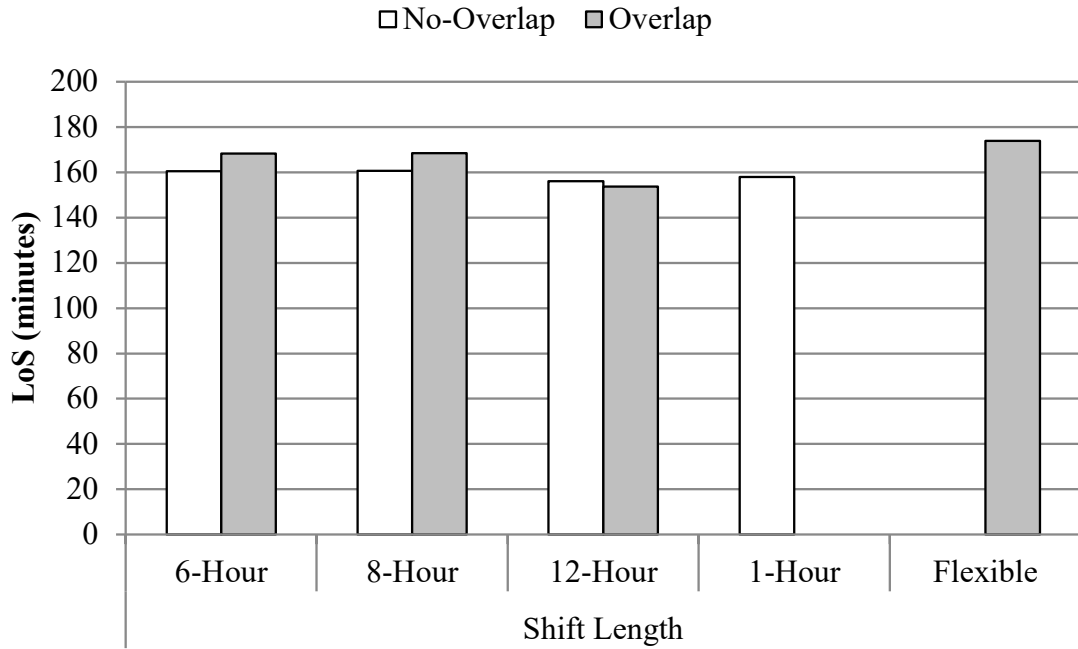

Figure 6.5. LoS comparison among various staffing

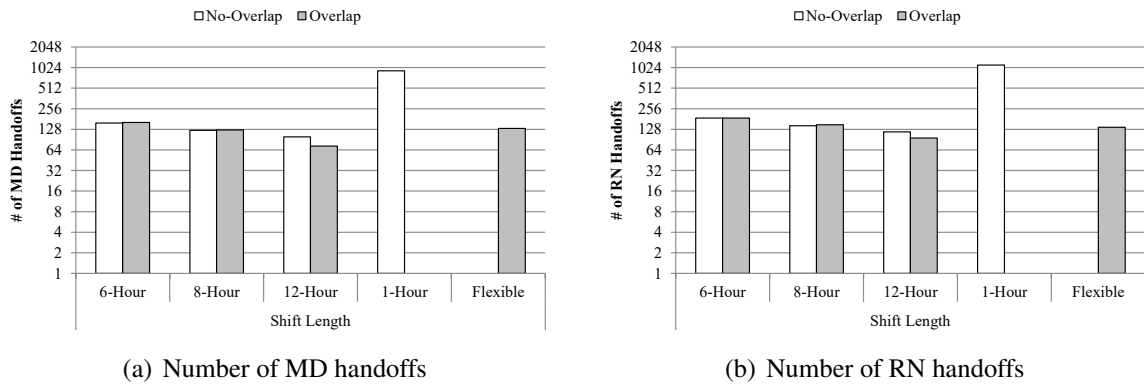

Figure 6.6. Number of handoffs comparison among various staffing

longer shifts result in fewer handoffs and that 1-hour staffing produces a larger number of RN handoffs than all other staffing options.

Finally, Figure 6.7 shows mean RN utilization for all the staffing options. It shows that, because overlapped staffing is closer to the staffing demands curve than staffing without overlap, overlapping leads to higher utilization. In addition, 6-hour and 8-hour staffing

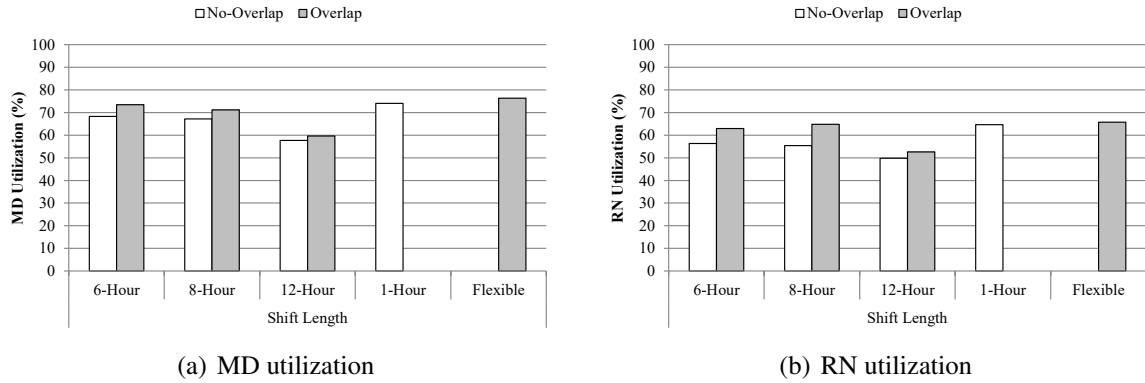

Figure 6.7. Utilization comparison among various staffing

show subtle differences in utilization, but 12-hour staffing shows lower utilization both for overlapping and non-overlapped staffing.

6.2.2 Comparison with Baystate Staffing Schedule

Figure 6.8 depicts RN staffing data for Baystate Medical Center ($RN(BMC)$), while $RN(50-60)$, $RN(60-70)$ and $RN(70-80)$ represent the RN staffing results obtained from my scheduling studies. Figure 6.8 compares LoS and contribution margin. As can be seen, when I set the utilization range to 70% - 80% $RN(70-80)$, the simulation results obtained are similar to $RN(BMC)$ staffing. Note also that the simulations designed to assure lower staff utilization levels provide interesting contrasts. For example, LoS is 20 minutes lower in $RN(50-60)$ but so is the contribution margin.

Figure 6.9, comparing average RN utilizations for a 24-hour day, and their standard deviations, shows that the variation in RN utilization levels is much lower in staffing results generated by my approach, and also for the $RN(70-80)$ case, which has approximately the same average as $RN(BMC)$.

Figure 6.10 provides insight into why $RN(BMC)$ has higher utilization variation compared to $RN(70-80)$, showing that RNs are underutilized in the less busy hours of the night, but are overutilized in the busy hours of the afternoon. Higher utilization in these busy hours implies increased LoS, while low utilization during less busy hours implies that personnel

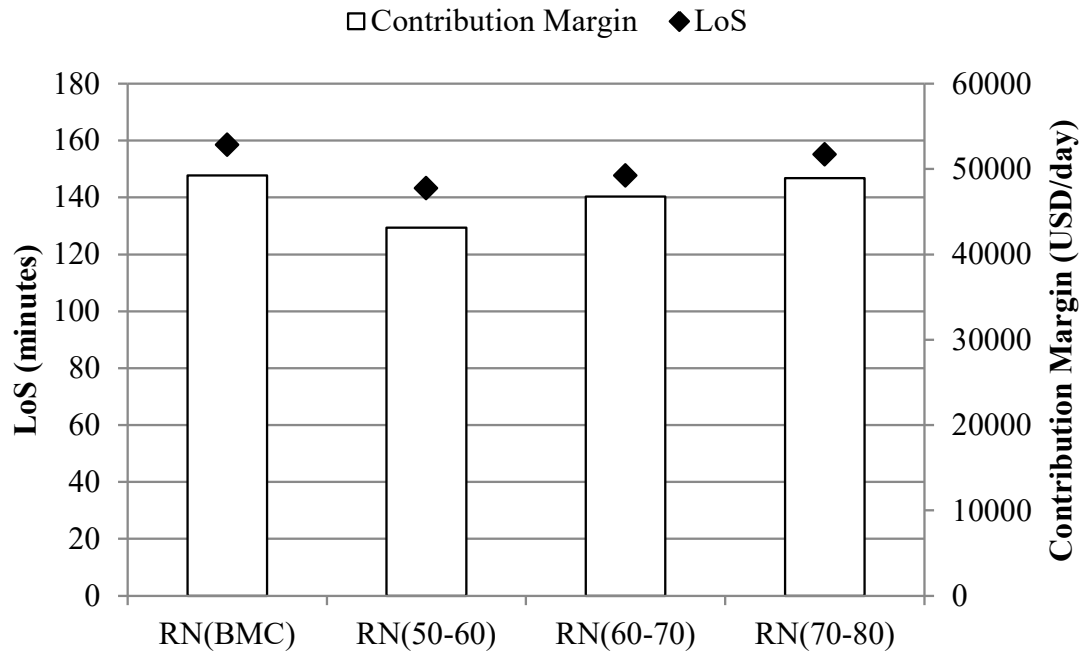

Figure 6.8. Patient’s LoS and contribution margin comparison: RN(BMC) RN staffing of Baystate Medical Center, RN(50–60) RN staffing derived by utilization limits 50%–60%, RN(60–70) RN staffing derived by utilization limits 60%–70%, and RN(70–80) RN staffing derived by utilization limits 70%–80%

costs are being wasted. However, as can be seen in Figure 6.10, my scheduling approach creates the improved RN staffing from the perspective of balancing the level of resource utilization over 24-hour period. The balanced resource utilization is one of the important goals in hospital resource management which leads to keeping the same quality of patient care over 24-hour period while optimizing resource utilization.

6.3 Process- and Resource-Aware Model Checking

Secondary hypothesis 3: Formal resource policy specifications allow verifying resource properties.

My process- and resource-aware discrete-event simulation provides detailed trace information about resource utilization to dynamically analyze different resource utilization policies. However, this dynamic analysis is valid only when the simulations of resource

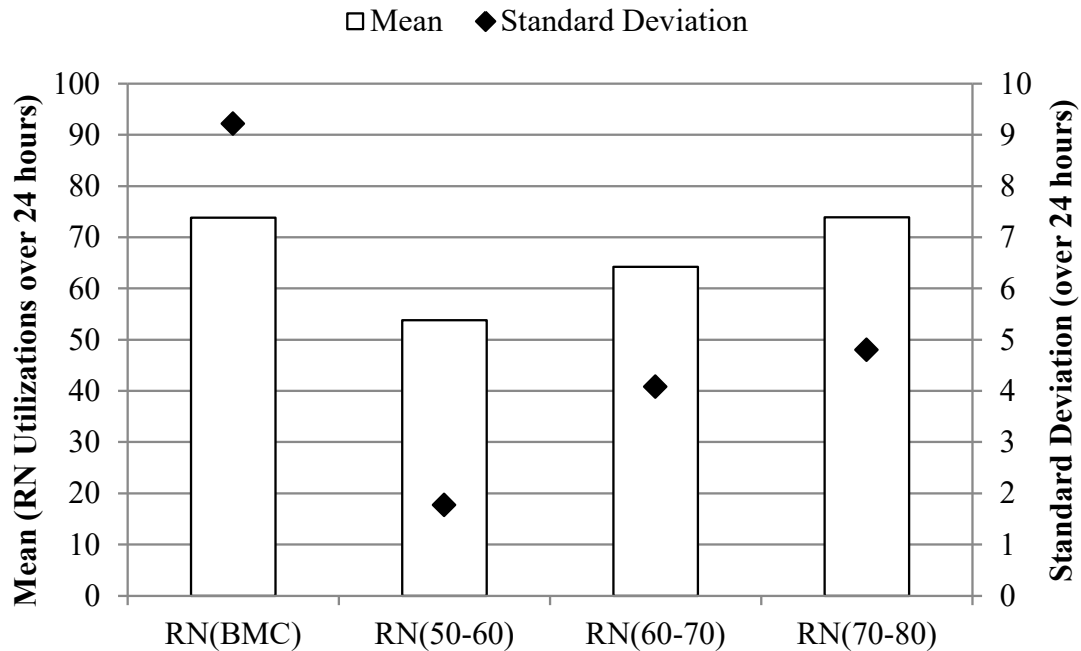

Figure 6.9. Utilization comparison: RN(BMC) RN staffing of Baystate Medical Center, RN(50–60) RN staffing derived by utilization limits 50%–60%, RN(60–70) RN staffing derived by utilization limits 60%–70%, and RN(70–80) RN staffing derived by utilization limits 70%–80%

utilization always adhere to the intended resource utilization policies. Therefore, I test the above secondary hypothesis to show that the formality of my specification enables analysts to verify resource properties such as the absence of violations of resource utilization policies and the absence of deadlock.

Given the entire ED specifications in Chapter 4, this chapter demonstrates how my static analysis approach verifies the adherence to policies/constraints such as the same doctor policy, shift policy, and capacity constraints in Section 6.3.1; and finds conflict among policies or detects a resource deadlock in Section 5.3.5. Last, Section 6.3.3 shows scalability characteristics of my approach.

6.3.1 Verification of Adherence to Resource Utilization Policy

First, I verified whether the specified patient care processes in an ED satisfy the same doctor property or not. For this verification, I used three doctors (md0, md1, and md2 all

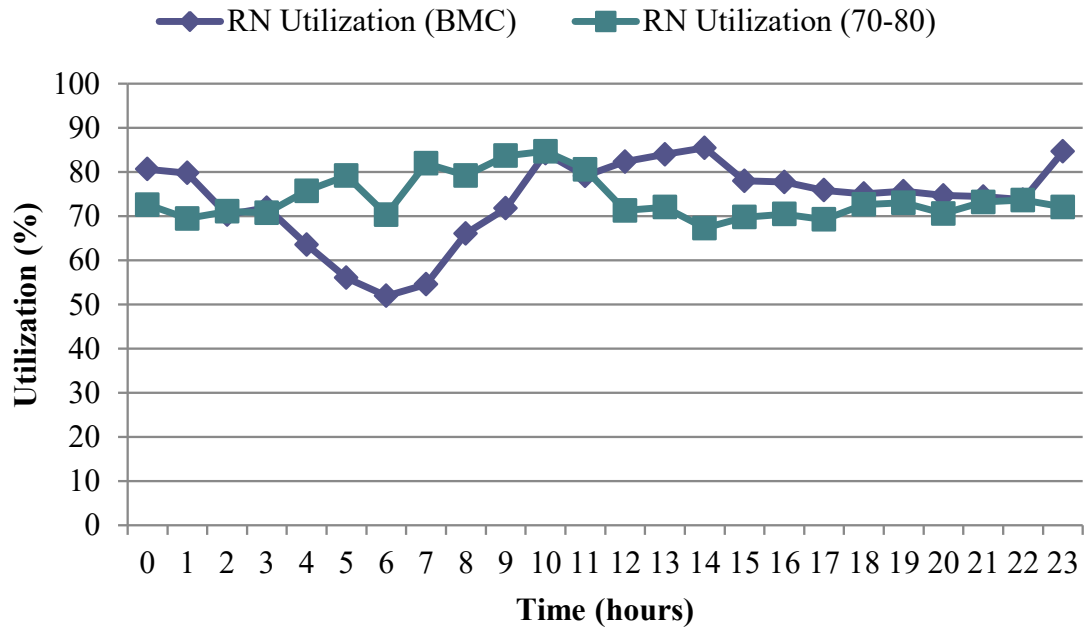

Figure 6.10. Utilization comparison over 24 hours a day: RN Utilization(BMC) RN utilization of Baystate Medical Center, RN Utilization(70-80) RN utilization derived by utilization limits 70%–80%

working on the same shift) , one patient, and including only the same doctor policy. Even though I include only one patient in this verification setting, there are still many possible cases that can violate the same doctor property such as faults in the specified policies. Given the same staff property in Figure 5.20, I bound events in the property FSM to concrete resource utilization events as presented in Figure 5.21. My verification reports that the ED model always adheres to the same doctor policy.

Second, I verified the adherence to the shift policy in my ED model. To verify the adherence, I specified the shift property FSM as presented in Figure 6.11. My approach of using FLAVERS and Little-JIL does not support continuous times. To verify the shift property which requires time information, I added a timer process into my patient care processes which generates three discrete time events: `time 0`, `time 8`, and `time 16`.

Figure 6.12 shows a timer process specifying the time progress of (0 → 8 → 16 → 0 → ...). As can be seen in Figure 6.12, the timer process is parallel with the patient care

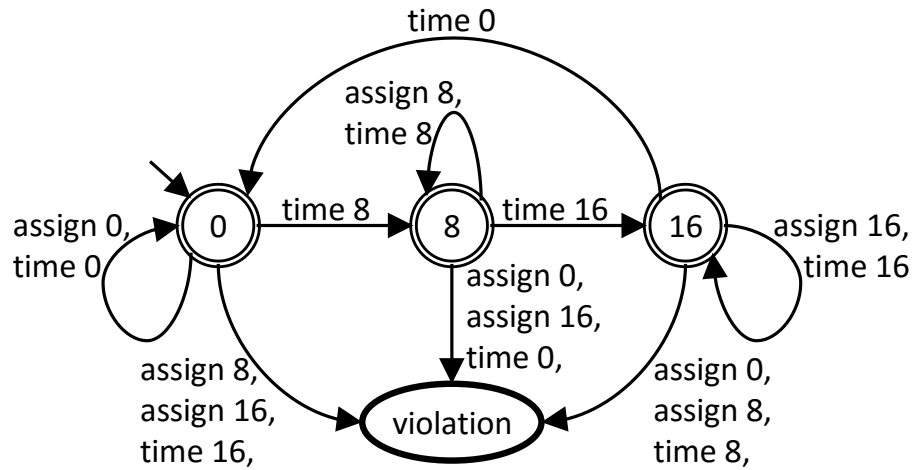

Figure 6.11. This property FSM encodes the shift property assuming there are three discrete time events: time 0, time 8, and time 16.

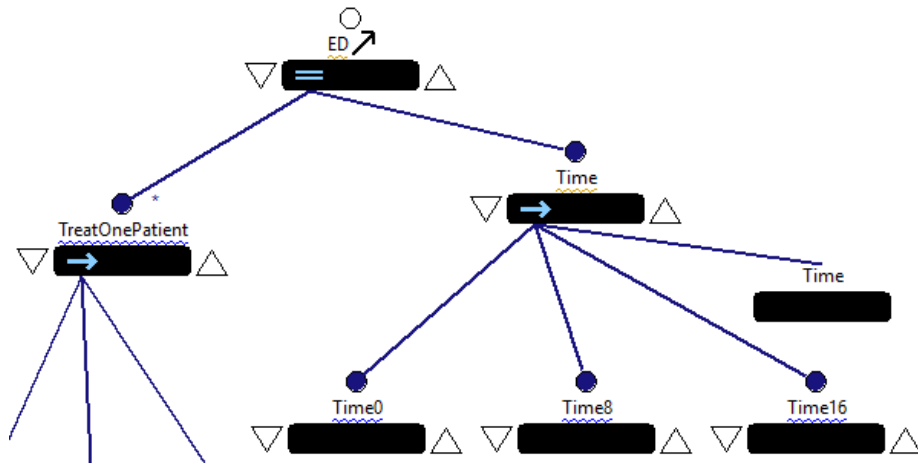

Figure 6.12. Timer process that generates three discrete time events: time 0, time 8, and time 16.

processes. This parallel structure allows all possible interleaving executions between the time progress and sequences of patient care activities. Time events of the shift property FSM in Figure 6.11 are bound to the associated start events of `Time` leaf activities in Figure 6.12.

To verify the shift property, I used three MD resource objects: `md0`, `md1`, and `md2` where `md0` works $[0, 8)$ times, `md1` works $[8, 16)$ times, and `md2` works $[16, 24)$ times. Thus, as can be seen in Figure 6.13, `assign 0` event, resource assignments at 0 time, is bound to all resource utilization events of the `md0`'s assignments to any patient care activities (see `/**` in Figure 6.13). Similarly, I mapped `assign 8` and `assign 16` events to concrete resource

Event name	Resource event binding
assign 0	assign(md0, /**)
assign 8	assign(md1, /**)
assign 16	assign(md2, /**)

Figure 6.13. An example of resource event binding for the shift property assuming three MD resource objects (md0, md1, and md2). The event names are declared in Figure 6.11.

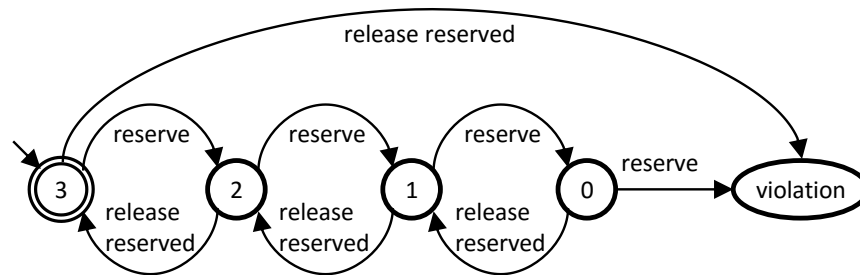

(a) Reservation capacity property FSM

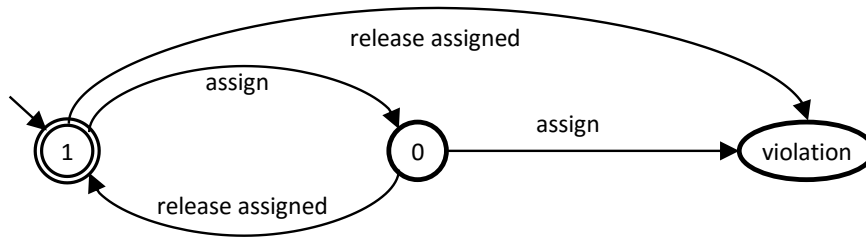

(b) Assignment capacity property FSM

Figure 6.14. Doctor’s capacity property FSMs. (a) A doctor can be reserved for three patients at most. (b) A doctor can care for one patient at the same time.

utilization events. This verification study includes only the shift policy. Based on the shift verification, I can assure that my ED model always adheres to the shift policy.

Last, I verified my ED model to see whether it always adheres to the capacity constraints. Since I decompose an allocation into a reservation and assignment, the resource capacity properties can be specified by using reservation and assignment events as can be seen in Figure 6.14. Given the event binding in Figure 6.15, Figure 6.14(a) states that a doctor must not be reserved for more than three patients. Figure 6.14(b) represents that a doctor is

Event name	Resource event binding
reserve	reserve(md0, //*)
assign	assign(md0, //*)
release reserved	release_reserved(md0, //*)
release assigned	release_assigned(md0, //*)

Figure 6.15. An example of resource event binding for the capacity property of an resource object (md0). The event names are declared in Figure 6.14.

allowed to care for only one patient at a time. For the verification of the two properties, I did not include other policies and I separately verified each patient care process of different patient acuity level (i.e., acuity level 1, 2, 3, 4, 5, and critical patient care processes) due to the scalability issues described in Section 6.3.3. For instance, I verified the acuity level 1 patient care process with four patient arrivals and 1 doctor resource object. This verification reported that the two properties hold.

As can be seen in this section, my approach allows analysts to select which policies to include in verification. This policy selection capability enables identifying which policies create a conflict condition while enforcing them together (see Section 6.3.2). In addition, the policy selection facilitates incremental verifications of resource utilization policies. However, even though the above verifications demonstrate the feasibility of verifying adherence to resource utilization policy, their verification settings related to patients, doctors, other resources, and patient care processes are simpler than the simulation settings because of the scalability issues (see Section 6.3.3). The scalability issues require further research.

6.3.2 Reachability Analysis

As described in Section 5.3.5, the existing FLAVERS is not able to detect the conflict problem between multiple policies. For instance, even if I include the shift and same doctor policies in my ED model, both the shift and same doctor properties still hold when using FLAVERS because the problem traces are deleted by a set of constraint FSMs. This

Counter example (resource utilization):

```
(time 0) →  
...→  
(request_assign MD from assess) →  
(assign md0 to assess) →  
(request_assign from procedure) →  
(assign md0 to procedure) →  
...→  
(time 8) →  
(request_assign from check CT)
```

Figure 6.16. A counterexample violates that a `request_assign` event must be followed by an associated `assign` event.

section shows my evaluation results that demonstrate how my reachability analysis detects a problem trace that happens while enforcing multiple policies such as the same doctor and shift policies. In addition, this section demonstrates my deadlock analysis results.

First, given the ED model with the timer process in Figure 6.12, this reachability analysis study includes one patient and three doctor resource objects: `md0`, `md1`, and `md2`. `md0` works on $[0,8]$ time period, `md1` works on $[8,16)$ time period, and `md2` works on $[16,24)$ time period. In this example, I include only the same doctor and shift policies. After running my reachability analysis to verify that all request events must be followed by associated allocation events, a counterexample in Figure 6.16 is generated. Figure 6.16 shows a counterexample trace that is paused after `time 8` due to the conflict between the shift and same doctor policies. As can be seen in the counterexample, `md0` working on $[0,8)$ time period cares for a patient until `time 8`. After `time 8`, however, `md0` is not able to care for the patient because of the shift policy. Even though `md1` working during the $[8,16)$ time period can handle the patient, care by `md1` violates the same doctor policy.

Second, the above verification proves that there is a conflict between the same doctor and shift policies. To resolve this conflict, I include the handoff policy described in Section 3.3. After this modification, the verification results show that there are no conflicts; however,

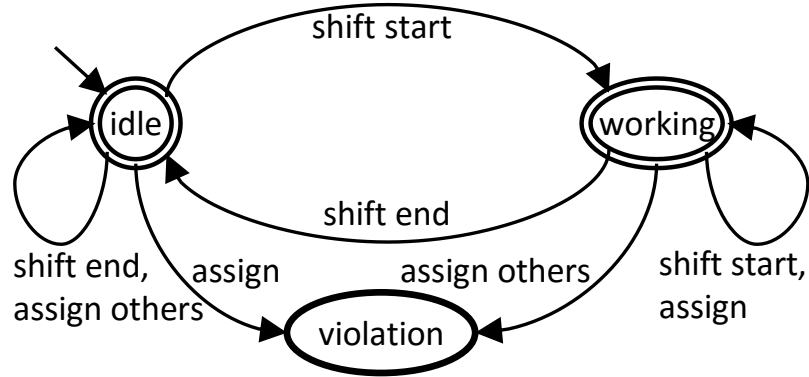

Figure 6.17. This same staff property represents a medical provider can care for a patient only during the medical provider’s shift hours.

Event name	Resource event binding
assign	assign(md0, //*)
assign others	assign(md1, //*), assign(md2, //*)

Figure 6.18. An example of resource event binding for the same staff property in Figure 6.17.

the same doctor property in Figure 5.20 is violated. This violation is caused by the handoff policy that allows a situation in which a patient can be cared for by other doctors. I edit the same doctor property by using shift restriction as presented in Figure 6.17, resource event bindings in Figure 6.18. `shift start` and `shift end` events in Figure 6.17 is bound to start events of `time0` and `time8` activities in Figure 6.12. Given this verification setting, my verification results show that the same doctor and shift properties hold without having a conflict between the same doctor and shift policies.

Last, based on this reachability analysis, I could find a resource deadlock trace in my initial version of ED model. When I verified the critical patient care process in my ED model with two patients, one doctor, and one nurse, a counterexample in Figure 6.19 is generated. The counterexample trace is stopped after assigning `md0` to `prepare patient activity to care for patient 1` and `rn0` to `prepare patient activity to care for patient 2`. Resource deadlock process in Figure 6.20 is a part of my critical care process which models the

Counter example (resource utilization):

```
...→  
(request_assign MD from prepare patient[1]) →  
(request_assign RN from prepare patient[1]) →  
(assign md0 to prepare patient[1]) →  
(request_assign MD from prepare patient[2]) →  
(request_assign RN from prepare patient[2]) →  
(assign rn0 to prepare patient[2])
```

Figure 6.19. A resource deadlock trace in the critical patient care process in my ED model.

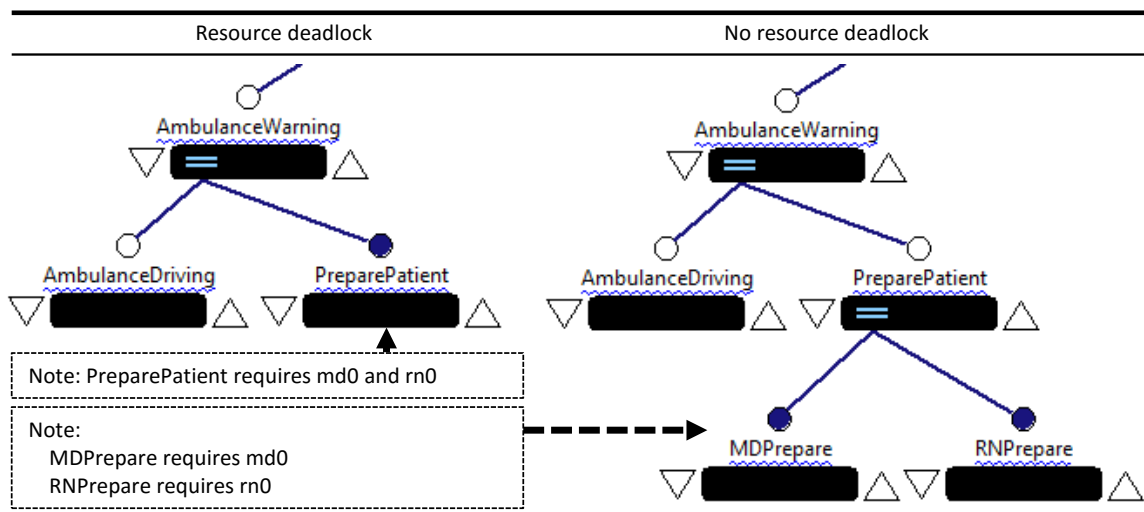

Figure 6.20. Two process specification having a resource deadlock problem and not having the problem.

preparation of a doctor and nurse for an arriving critical patient. Based on my domain expert's guide, I assume a critical patient is arriving by ambulance. While the patient is in the ambulance, a doctor and nurse are preparing for the arrival (see PreparePatient activity requires md0 and rn0). In this verification setting, if two patients arrive at the same time, two PreparePatient activities for each patient can be blocked from waiting to acquire resources which are held by each other as can be seen in the counterexample. This resource deadlock problem is unlikely to happen in my simulations because critical patient arrivals rarely happen in my ED model and the modeled ED has always sufficient doctors and nurses

to care for multiple critical patients. However, this resource deadlock problem can still occur and if so, can influence the simulation results. To avoid the resource deadlock problem, I decomposed `PreparePatient` activity into `MDPrepare` and `RNPrepare` activities where each activity requires `md0` and `rn0`, respectively. This modification eliminates the resource deadlock problem because it does not create a condition of circular resource waiting among multiple activities. Each of `MDPrepare` and `RNPrepare` requires only one resource object to be executed.

6.3.3 Scalability Characteristics

To test the scalability of my static analysis approach, my verification evaluations were run on an Amazon EC2 server (c3.8xlarge) with 34 virtual CPUs (2.5GHz) and 60GB memory. Given the ED model, I ran various verification scenarios by changing the combinations of policies, capacity constraints, the number of patients, and the number of resource objects/types. Among the verification results, this section includes some experiments that show the scalability characteristics of my approach. In this section, `AL1`, `AL3`, and `AL4` stand for the patient care process to care for acuity level 1, 3, and 4 patients, respectively. `Critical` stands for the patient care process to care for critical patients. `All` stands for the entire patient care processes to care for acuity level 1,2,3,4,5, and critical patients. For the scalability study, I terminated a verification run if it required more than 2 hours.

Figure 6.22 compares how many patients can be included in a verification setting to verify each within 2 hours. `No policies` verification results came from verifications without any policies. `Same MD policy` results are derived from verifications including only the same MD policy. `Shift policy` verifications were run by including only the shift policy. `Same MD and Shift policies` include both the same MD and shift policies in the verifications. In this example, I included 2 doctor resource objects, did not include capacity constraint FSMs, and verified the ED completion property in Figure 6.21. As can be seen in Figure 6.22, there are subtle differences between `No policies` verifications and `Same MD`

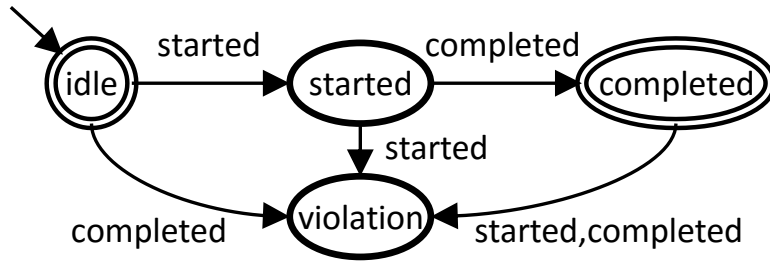

Figure 6.21. This property FSM represents a patient care process must be completed once started. `started` event is bound to the `started` event of the root activity of my ED activity model. `completed` event is bound to the `completed` event of the root activity of my ED activity model.

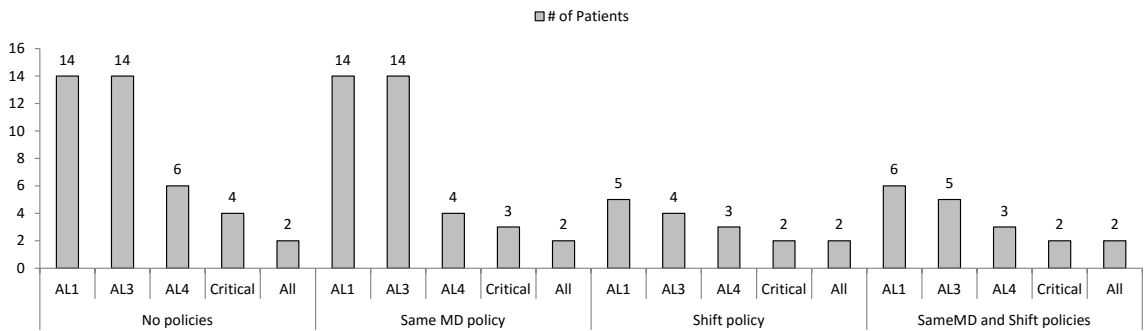

Figure 6.22. Comparison of how many patients can be included in analysis settings which vary the combination of policies.

policy verifications. However, adding `Shift` policy significantly worsens the scalability of handling multiple patients. However, interestingly, adding both `Same MD` and `Shift` policies yields better results of the scalability than only including `Shift` policy. As can be seen in Figure 6.23, the TFG size of the `Same MD` and `Shift` policies is smaller than the `Shift MD` policy. In addition the verification of the `Same MD` and `Shift` policies took 6 minutes which is shorter than the verification time of the `Shift` policy case, 19.8 minutes. `Same MD` policy creates dependency between resource allocations to allocate the same doctor resource object to care for a patient. This dependency provides a better chance for FLAVERS optimization.

	No policies	Same MD policy	ShiftMD policy	Same MD and Shift policies
# TFG nodes	304	446	1045	851
# TFG edges	12226	41181	124633	43838
# Tasks	21	21	21	21
# Constraint FSMs (CFSMs)	47	51	48	52
Mean # of States in CFSMs	9	11	25	19
Mean # of Transitions in CFSMs	41	58	200	174

Figure 6.23. Comparison of the sizes of analysis problems associated with verifications with all processes in Figure 6.22.

	ED completion property	Shift property
# TFG nodes	1045	1217
# TFG edges	124633	124761
# Tasks	21	21
# Constraint FSMs (CFSMs)	48	48
Mean # of States in CFSMs	25	28
Mean # of Transitions in CFSMs	200	211

Figure 6.24. Comparison of the sizes of analysis problems by only changing property FSMs.

Figure 6.24 compares analysis problem sizes between two verification settings that vary property FSMs (ED completion property and Shift property). For this verification comparison, I used 2 doctor resource objects and 2 patients with all patient care processes and only the shift policy (no capacity FSMs). As can be seen in Figure 6.24, there are subtle differences between the two cases. Therefore, verification times for the two cases are also similar: 19.8 minutes (ED completion property) and 20 minutes (Shift property). I found similar results when I compared the verification of ED completion property with the verification of Same MD property. The similarity in these sizes of the analysis problems is caused by a resource utilization policy already adding associated resource utilization complexities such as resource events and constraint FSMs to the analysis problem. Therefore, verifying a resource property does not significantly worsen scalability.

Figure 6.25 compares the number of patients which can be verified within the 2 hours verification time limit by configuring capacity constraint FSMs and policies. For this comparison, I verified the ED completion property with 2 doctor resource objects. As can be seen in Figure 6.25, adding capacity constraint FSMs worsens the scalability of handling multiple patients significantly. Capacity constraint FSMs include all resource allocation and

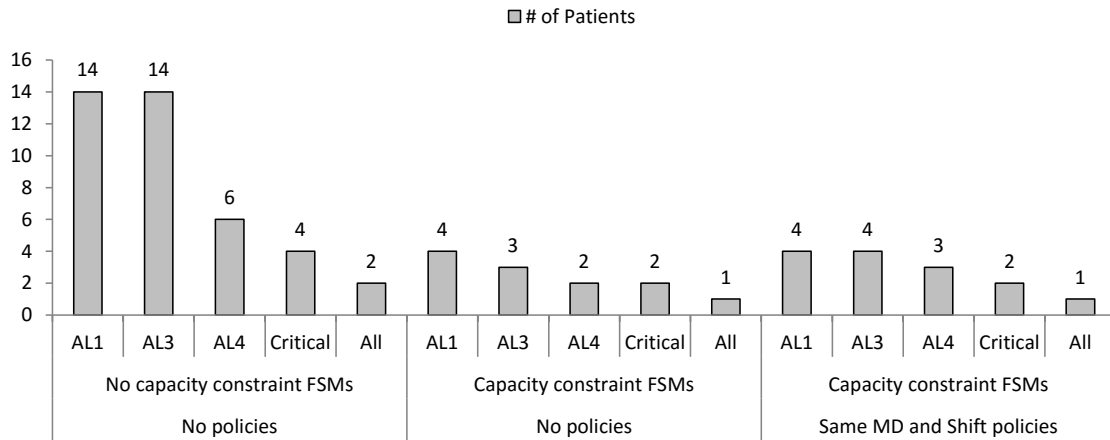

Figure 6.25. Comparison of how many patients can be included in analysis settings which vary capacity constraint FSMs and policies.

	Same MD and Shift policies	+ Handoff policy
# TFG nodes	775	2239
# TFG edges	5448	7636
# Tasks	11	11
# Constraint FSMs (CFSMs)	30	30
Mean # of States in CFSMs	29	78
Mean # of Transitions in CFSMs	296	457

Figure 6.26. Comparison of the sizes of analysis problems by changing only handoff policy.

release events which influence increasing the size of a TFG to encode all the resource events. After adding capacity constraint FSMs, additional policies do not influence scalability.

Figure 6.26 compares two analysis problem sizes between the **without** (Same MD, Shift, and Capacity) and **with** handoff policy (Same MD, Shift, Capacity, and Handoff). To compare this case, I verified the ED completion property based on 2 doctor resource objects and 1 patient with all patient care processes and capacity constraint FSMs. As can be seen in Figure 6.26, + Handoff policy increases the TFG size significantly because a conflict resolution policy creates additional control flows in a BIR program which is translated to a TFG (see Section 5.2.2).

Figure 6.27 shows the verification results by changing only the number of doctor resource objects. To test the scalability of varying the number of resource objects, I verified the ED completion property by using 1 patient with all patient care processes, all policies (shift,

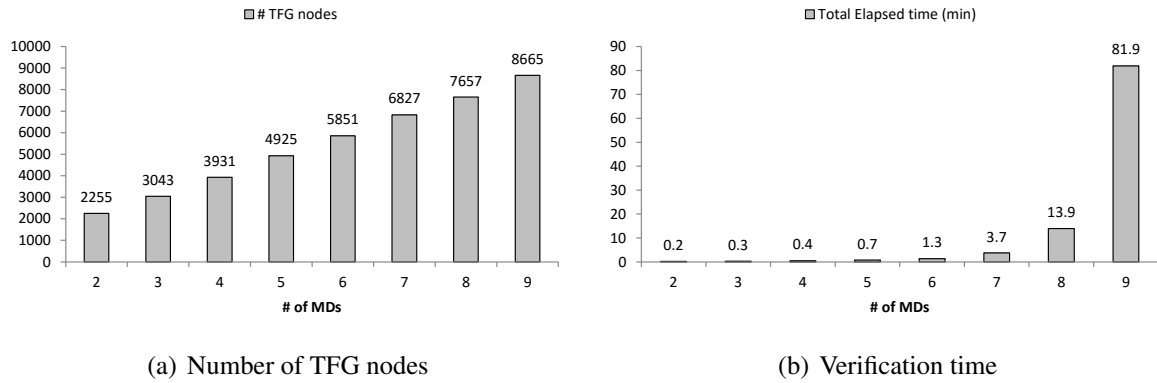

Figure 6.27. Verification results by changing the number of doctor resource objects. (a) compares the number of TFG nodes. (b) compares the elapsed verification times.

	2 MDs, 0 RNs	0 MDs, 2 RNs	2 MDs, 2 RNs
# TFG nodes	2255	2471	4784
# TFG edges	7624	5215	15378
# Tasks	11	11	11
# Constraint FSMs (CFSMs)	30	30	34
Mean # of States in CFSMs	79	86	144
Mean # of Transitions in CFSMs	459	482	679

Figure 6.28. Comparison of the sizes of analysis problems by changing the combinations of including different resource types.

same MD, and handoff), and resource capacity constraints. As can be seen in Figure 6.27, the number of TFG nodes increase linearly as the number of doctor resource object increases. As can be seen in Section 5.3.2, TFG size depends on the number of resource objects. Similarly, the number of constraint FSMs increases linearly. However, the verification time increases exponentially because the verification time of FLAVERS is dependent exponentially on the number of constraint FSMs.

Figure 6.28 shows the impacts of three resource configurations on the sizes of the analysis problems: 2 MDs, 0 RNs, 0 MDs, 2 RNs, and 2 MDs, 2 RNs. For the comparison, I verified the ED completion property with 1 patient, all patient care processes, all policies (shift, same MD-RN, and handoff), and capacity constraints. As can be seen in Figure 6.28, the TFG size of 2 MDs, 2 RNs is approximately similar to the sum of the TFG sizes of 2

MDs, 0 RNs and 0 MDs, 2 RNs. In addition, Figure 6.28 shows that the number of tasks does not depends on the number of resource objects.

CHAPTER 7

RELATED WORK

Sound resource management is a very important but hard problem. Resource management problems have been widely studied in many kinds of systems such as healthcare systems, operating systems, cloud systems and so on. This chapter describes prior works that are closely relevant to my proposed research.

7.1 Modeling

Related to my model-based approach, there are many studies to specify various dimensions of systems. In this section, I present prior work by focusing on how their approaches describe resources. Based on my investigations, most of this prior work has difficulty in specifying complex resource concerns such as resource utilization policies in a flexible manner. However, my resource specification approach is capable of specifying diverse resource characteristics, complex management constraints and conflict resolutions by separating these resource concerns.

7.1.1 Process Modeling

Business Process Model and Notation (BPMN) [46] was developed by the Object Management Group (OMG) to provide a single standard notation for business processes. BPMN provides graphical notations for conceptual business processes that are intended to be readily understandable by all business process stakeholders such as analysts, developers and business people. This modeling approach specifies business processes through collaboration diagrams, process diagrams and choreography diagrams. First, collaborations are defined

by a collection of participants in pools and their interactions by message flows. Second, a process describes a sequence of activities in an organization. Third, a choreography formalizes interactions between participants by focusing on the exchange of information. To specify resources, BPMN uses two basic abstractions: resource and resource class. BPMN defines a resource as anything or anyone involved in the performance of a process activity. A resource class defines a set of resources with shared characteristics that can be referenced by activities. A resource class can represent either a role or a group. A role classifies resources based on what a resource can do or is expected to do. On the other hand, a group classifies resources by an organization's structure. These resource classes are captured by using pools. Therefore, a collaboration diagram represents collaborations between resources by using message flows. A choreography defines expected behavior - a procedural business contract between interacting resources. However, BPMN does not include resource management issues such as resource allocation under various constraints or conflict among multiple utilization policies.

Yet Another Workflow Language (YAWL) [65] provides a workflow specification language based on Petri nets. YAWL extends Petri nets to support various kinds of workflow patterns [70] such as control-flow, data, resource, exception handling and managing process model complexity patterns. YAWL divides workflow specification into control-flow, data and resource perspectives. Control-flow perspective defines tasks and their interaction flow relations. Data perspective specifies how and when data values are created, passed and populated. Resource perspective defines what human and non-human resources are required to perform the work items in a selected task. YAWL divides resources into primary and secondary resources. Primary resources are human resources that actually perform a work item. However, secondary resources consist of both human and non-human resources that assist primary resources. Related to resource decisions such as work item offers, resource allocations and work item starts, YAWL provides two interaction strategies (decision by system and by user) for work items of a selected task. Interaction strategies can be decided

at three interaction points such as the offer, allocation or start. Offer by system strategy means that a system selects a resource automatically to perform a work item. Offer by user, however, requires an administrator to select a resource for a work item at runtime. In the offer specification, YAWL provides constraints that specify which work items are allowed or prevented from being performed by primary resources. At the allocation point, allocated by system means that resources are selected by the system; however, allocated by user allows resource participants to decide their work items by themselves. At start point, started by system indicates work items will be immediately started after allocation. On the other hand, started by user allows manual start of the work items by resource participants. This approach separates resource concerns from control-flow and data perspectives. However, the specification capabilities of resource constraints are restrictive. For instance, YAWL does not support conflict resolution strategies among multiple resource utilization policies.

Web Services Business Process Execution Language (WS-BPEL) [44] specifies business processes based on web services. WS-BPEL supports two kinds of specifications for executable and abstract business processes. To support business transactions, WS-BPEL extends the Web Services interaction model. WS-BPEL uses several XML specifications such as WSDL, XML schema, XPath and XSLT. To define a data model, WS-BPEL specifies the model by using WSDL messages and XML schema type definitions. XPath and XSLT provide support for data manipulation. All business partners or external resources are represented by using WSDL services that describe the functionality offered by a web service. However, WS-BPEL does not include human interactions essential to business processes. Therefore, BPEL4People [14] has been extended from WS-BPEL to incorporate role-based human activities as well as web services. In contrast to my approach, WS-BPEL does not provide any explicit specification to capture resource management characteristics in business processes.

7.1.2 Policy Modeling

Systems incorporate policies to guide behavioral decisions of participants to achieve system goals. Many prior studies have focused on policies to implement flexible and adaptive systems for management of internet services, distributed systems and security systems. Damianou et al. [16] divide policy specification languages into security and management policies. Many prior works have provided security policy (or access control policy) languages to specify that only authorized subjects are permitted to access targets such as services or resources [19, 24, 45, 53, 55]. Sandhu et al. [55] provide role-based access control models (RBAC). RBAC defines users, permissions and sessions that are related to roles. In addition, they specify role hierarchy as well as constraints to restrict the assignments of users or permissions to specific roles. Ribeiro et al. [53] provide an event-driven policy language that supports access control, history-based and obligation-based policies. XACML [45] defines information access control policies for securely browsing documents over the Internet. In contrast to these security policy specification languages, management policy specification languages define dynamically adaptable management strategies [9, 36, 38, 42, 62] that facilitate modifying the management approach in a flexible manner. Moore et al. [42] define a policy core information model for network policies. Network policy defines the relation between clients using network resources and the network elements providing those resources. Burgess et al. [9] provide configuration policies for a system administration tool which automates configuration of all networked hosts. However, none of these policy specification languages aim to address resource management problems that my proposed research is considering. Resource utilization policies are important to be considered carefully in system design and analysis phases as well as these access control and configuration management policies of these prior studies.

Rei [30] is a policy specification language for pervasive computing applications. The policy language, Rei, aims to be very expressive but lightweight and easily extensible. Rei is based on deontic concepts and provides constructs for rights, prohibitions, obligations and

dispensations. An entity has rights of permission to perform the associated action only when certain conditions are true. On the other hand, prohibitions are negative authorizations that indicate an entity is not authorized to perform an associated action. Obligations are special actions that an entity must perform when a set of conditions is true. Dispensations, however, are special actions that an entity waives from existing obligations. To control these policies, Rei provides four speech acts: delegation, request, cancel and revocation. Delegation allows a transfer of a right between entities. Request defines queries for an action or a right. Revoke acts as a prohibition by removing a right. An entity can cancel any requests by the cancel speech act. Rei defines three cases of possible policy conflicts such as (1) conflict of right and prohibition, (2) conflict of obligation and dispensation, and (3) conflict of obligation and prohibition. Rei resolves these potential conflicts among multiple policies by priority and precedence meta policies. For instance, a priority meta policy can state that an ED policy overrides a hospital policy in the case of conflict. Precedence specifies negative or positive modality precedence. If negative modality holds, prohibitions hold over rights and dispensations are stronger than obligations for the entities that fulfill the associated conditions in the precedence meta policy. My proposed resource utilization policy specification is inspired by Rei. Resources have permissions that allow to perform an activity. I separate conflict resolution specifications in order to resolve conflicts among multiple resource utilization policies. However, Rei does not support any resource management issues such as request or resource selection for effective and efficient management, complex constraints in resource management and conflicts between multiple permissions.

7.2 Simulations

Simulation has been widely used to dynamically analyze the behavior of complex systems. This section describes prior works of simulations and their limitations from resource management perspective. Overall, despite the large number of these previous studies, in my view, none of them has supported the evaluation of complex resource utilization policies

in a flexible manner because most of them treat resources as other entities in their activity coordination models. My approach separates resource concerns to facilitate flexible support of resource decisions.

7.2.1 Simulations Tools

Arena [54] uses a resource module to specify resources in a system. The resources can be grouped together as a pool of resources (i.e., resource set). These resources are allocated and released by using seize and release modules. A resource has capacity which determines the number of resource units. The capacity can be varied over a simulation run by using a schedule module. A schedule module adjusts the capacity of a resource for a given period of time. Arena supports change of resource availability through variable capacity specification; however, if the availability depends on the resource's own characteristics, the resource model of Arena seems unsuitable to specify this dependency. For example, a doctor working in a fast-track cannot care for a patient in a main-track. In addition, if the doctor moves to the main-track to help resolve a crowded condition in the main-track, the doctor then becomes available to care for patients only in the main-track. In addition, Arena has difficulties specifying a conflict resolution among multiple resource utilization policies, for instance, the handoff in a hospital. Arena supports multiple schedule policies by adjusting patient queues; however, if an administrator wants to change the constraints from the sickest-first to a heuristic-based, entire patient queues and related patients' attribute modifiers have to be changed to support this.

SAS Simulation Studio [56] provides mobile resources as a special type of entity that flow in the model. A resource entity has attributes which can be used in processing like other entities. Because resources are a special type of entity, they have to be first created and then sent to a resource pool block to handle resource requests. Seize and release blocks are used to model resource allocation and release. There is a predefined entity attribute called ResourceUnits, which defines the number of units of a resource. By using a resource

schedule, the number of available resources can be varied during a simulation run. Attribute values of a resource can be used to specify different characteristics of resources. However, it is not sufficient to specify different kinds of resources that have different kinds of specialized capabilities. For instance, a nurse can provide patient-care capabilities such as assessment, ECG, blood work and so on. If the nurse becomes too busy to maintain high quality of patient care, she could hand over her ECG and blood work to a technician. What's more, SAS Simulation Studio also has limitations in supporting complex resource utilization policies as does Arena.

SimEvents [40] does not have resource-specific modeling modules; however, this does not mean that resource management systems cannot be modeled by using SimEvents. Like the approach of resource modeling in SAS Simulation Studio, an entity can be used to model a resource. An entity generator creates a number of resource entities, and then a queue stores the created resource entities. An entity combiner and an entity splitter can be used to model resource allocation and release, respectively. However, the lack of resource-specific modeling modules inherently increases the complexity of the entire system specification if an analyst want to study the resource constraints of a system.

FlexSim [22], Simio [60], and ProModel [49] incorporate physical location information in their models. In general, these simulation systems model a resource as stationary or mobile resources. Stationary resources handle an arrival entity at their fixed locations; however, mobile resources move to pick-up an entity to provide a service such as carrying an entity to other locations. These simulation systems help us see how a system operates visually. However, it is relatively difficult to specify resource constraints which involve inter-relations among entities, resources and activities. For instance, the same doctor constraint in an ED requires pairing a patient with a doctor. If the location of a patient is changed by a nurse, the patient's doctor should be aware of this changed location. These kinds of interactions would significantly increase the complexity of their communication specifications.

7.2.2 Hospital Patient Care Simulations

Related to my case study, many studies use simulations to analyze hospital resource management [6, 15, 20, 41, 47, 61]. Wang et al. [69] use a simulation model to identify potential changes in operational policies to reduce patients' length of stay. They suggest reassignment of nurse jobs, combining registration with triage, adding float nurses, mandatory requirement of physician's visit within 30 min, and the simultaneous improvement of durations of the most sensitive procedures to decrease the length of stay. Zeng et al. [76] use a simulation model to study the ED of a community hospital. Based on their sensitivity analysis, they suggest that adding nurses and CT scanners can reduce patient waiting times and length of stay. They also suggest that a team nursing policy (creating pooled capacities) can significantly improve ED efficiency. Brenner et al. [8] use simulation to identify bottlenecks and investigate the optimal numbers of human and equipment resources. In contrast to my work, these simulations oversimplify hospital resource utilization policies and even not include time-varying patient arrival rates, which are particularly important to model patient care in a hospital.

7.3 Static Analysis

My static analysis approach relies on the use of FLAVERS which is a finite state verification tool to analyze resource utilization policies. This section presents prior static analysis work which is related to formal verification and resource analysis. In contrast to my static resource analysis, this previous work has difficulty analyzing complex resource utilization policies. Encoding and analyzing complex resource utilization policies require a lot of efforts in using prior formal verification techniques. In addition, prior static analyses focusing on only a specific resource utilization problem such as resource contention and capacity limits based on relatively simplified resource models.

7.3.1 Formal Verification Tools

Formal verification techniques guarantee that system specifications are free from the violations of a given system property. Due to the fact that the precision demanded by today's systems is critical; many researchers have extensively studied formal verification techniques such as model checking [12, 26, 31] and theorem proving [11, 37, 57]. Model checking approaches build a system model by using a form of state transition system. They define a system property based on temporal logic. Given these system models and properties, model checking verifies whether the system satisfies the given property in all system executions. A basic analysis algorithm incorporates exploring a set of reachable states of models to assure a given property holds. These model checking approaches have wide applications. For instance, SPIN [26] model checker is used to verify a banking system [58]. On the other hand, theorem proving techniques do not require exhaustive searching of a system's state space to verify properties. Various kinds of logic and proof techniques, such as Hoare logic and inductive proof, are used in many theorem provers. Theorem proving techniques are also widely used in many applications. For example, Coq [11] theorem prover is used to formalize and verify a mail server (SMTP server) [1]. However, tools for these formal verification approaches often require a great deal of user expertise and effort. Analyzing complex resource utilization policies by using these verification approaches requires much intensive work by analysts. To circumvent this, my proposed research provides an automated translation algorithm from my resource specifications to describe transition systems (such as a FSM and an event trace graph) that can be used in a model checking approach (FLAVERS).

7.3.2 Static Resource Analysis

Li et al. [34] provide a resource constraints analysis approach for workflow specifications. They classify resources into two types: shared resources and private resources. Shared resources can be accessed by different activities; however, private resources are allowed to be accessed by only one activity. Given this classification of resources, Li et al. are interested in

shared resources because these resources may create a conflict between competing activities requiring the same shared resources. If multiple activities require the same shared resources, Li et al. relate these activities as a resource dependency relation. Then, they define a potential conflict in resource utilization as the simultaneous scheduling of activities in a resource dependency relation. Their analysis aims to detect this potential conflict in a workflow specification. They detect this conflict by using resource dependency and reachability information. Briefly, they first check the reachability of two activities with resource dependency. If an activity is reachable from another, they do not compete with each other for the shared resources. Otherwise, they further check whether scheduling these activities at the same time could result in a potential resource conflict. They extend this potential conflict detection algorithm for timed workflow specifications. However, their analysis capability is restricted to the resource contention problem. In addition, they do not consider any complex constraints in resource management such as resource utilization policies.

Wang et al. [68] introduce resource-constrained workflow model as well as a resource requirement analysis approach. They extend Workflows Intuitive Formal Approach (WIFA) [67] to take resources into account when modeling and analyzing workflows. Given the formal workflow definitions in WIFA, they formally define resources and their participation such as resource consumption for starting a task, resource production after executing a task, and resource-ready for the required amount of resources to start a task and state transition rules related to resources. Given a formal workflow description, they are interested in a sufficient resource set (SRS). If an SRS is satisfied in a workflow, the workflow can be executed without of resource shortage. To analyze an SRS, they find out the maximum amount of each type of resources that can be held or consumed in the execution of a workflow by examining a workflow task-by-task from the starting task to ending task. Wang et al. [66] improve this algorithm's efficiency by using block or branch information in a workflow. However, this approach analyzes resource capacity based on very simplified

resource models. Complex resource utilization policies significantly influence resource capacity management that aims to improve efficiency in a workflow.

Besides these resource analyses in a workflow (or process) domain, many program analysis techniques have been developed to address resource analysis problems related to resource utilization such as deadlock [18, 43, 71] and resource leak [29, 63, 64]. Naik et al. [43] provide an effective static deadlock detection approach for Java. Their algorithm uses novel combinations of static analyses to detect a set of conditions that cause a deadlock. Sui et al. [63] introduce a static memory leak detection algorithm by using full-sparse value-flow analysis. They use a sparse value-flow graph to capture def-use chains and value flows for all memory locations. Given the value-flow graph, they perform reachability analysis to detect a memory leak. However, these resource analysis techniques for software programs depend on specific resource types and resource utilization constructors provided by specific languages. For instance, memory leak detection approaches depend on languages such as C or Java based on the difference between explicit memory management and garbage collection.

Unified Modeling Language (UML) is often used to design software; however, scattered resource information in UML diagrams increase the difficulty in analyzing resource properties. Petriu et al. [48] introduce Core Scenario Model (CSM) to bridge between UML based software specifications and performance analysis models such as layered queuing networks and Petri Net. CSM extracts resource use information from UML specifications because UML specifications have scattered resource information. They categorize resources as ExternalOperation, ProcessingResource, and Component; and model resource usage flow by using resource acquisition and release to specify how long resources are used and what order they follow. However, CSM does not directly address the specification and analysis challenges inherent in complex resource utilization policies.

7.4 Resource Management

This section presents prior work related to resource management in the area of broad system research. In contrast to my approach, most of this resource management research centers on strategies of resource allocation and scheduling. They have focused relatively less on modeling diverse and complex resource characteristics and utilization policies.

7.4.1 Resource Management in Operating Systems

One of the main responsibilities of an operating system is resource management. Competing applications share system resources such as processors, memory, caches, storage, and I/O devices. These resources should be managed adequately to respond to changes in application contexts under various constraints such as response time and power consumption. Boyd-Wickizer et al. [7] provide a scheduling algorithm that maximizes utilization of distributed on-chip memory in multicore processors. The main challenge in maximizing on-chip memory utilization is that the memory be split up among the cores in the form of many small caches. Their approach shows that scheduling based on scheduling objects and operations to caches and cores, rather than scheduling to optimize CPU cycle utilization, is better in terms of utilizing on-chip memory. Holey et al. [25] provide a novel shared cache management policy for a heterogeneous multicore processor that takes advantage of the CPU's tolerance for memory access latency. Their shared cache management policy not only improves performance but also reduces energy consumption in the cache module. Xu et al. [75] provide automated power management approaches in OS-level for devices. Current approaches place power management burdens on device driver developers, who have often failed in the development of efficient power management. To address this problem, they develop a central power management agent that automatically performs runtime power management. Most of this research focuses on a specific resource type because system resources' utilization is often followed by fixed specifications of operating systems.

7.4.2 Resource Management in Clouding Systems

Resource management in a cloud environment plays a key role in today's Internet services. Jennings et al. [28] categorize the subjects of a cloud resource management system by categorizing types of resources such as compute resources, networking resources, storage resources, and power resources. Compute resources are a collection of physical machines. In a clouding environment, physical machines are typically hidden by virtual machines which may share the same physical resources. Ahn et al. [2] provide two cluster-level virtual machine scheduling techniques for traditional system resources such as cache and non-uniform memory access affinity to mitigate the contentions among them. Efficient management of networking resources is important because these physical machines are interconnected with a high-bandwidth network. To provide predictable latency and bandwidth in a data center network, the virtualization of a data center network is considered a promising approach [5]. Wood et al. [73] provide optimized support for live WAN migration of virtual machines that minimizes the cost of transferring storage and virtual machine memory during migrations over low bandwidth and high latency Internet links. Management of storage resources is different from traditional database systems because scalability is critical in cloud systems. Depending on the number of users, load, or data volume, storage services should be dynamically scaled. To achieve scalable storage, distributed key-value stores such as Cassandra [32] and Dynamo [17] are used for Facebook and Amazon, respectively. To address power management issues in cloud systems, prior work has developed energy efficient techniques for energy-aware resource management, low power components to improve hardware energy efficiency, more efficient cooling systems, and applications. Mathew et al. [39] provide an energy efficient content delivery network using an algorithm for cluster shutdown based on realistic power models. Most of this prior work has focused on non-human resources and plays little attention to the nature of resources and their utilization policies from a general perspective.

CHAPTER 8

CONCLUSIONS

Contemporary systems often require effective support of many types of resources, each governed by complex utilization policies. Efficient and effective management of these resources is crucial in assuring that these systems achieve their key goals. To help system developers make efficient and effective resource management decisions, I have developed a framework of resource utilization policy specification and analysis.

8.1 Discussions

Many systems integrate various resources such as human, software, and hardware resources necessary to perform activities in the systems. System participation by these resources is often restricted by diverse resource utilization policies. Further, policies may at times conflict with each other, requiring conflict resolution strategies that add extra complexity. My resource specification approach (1) separates resource utilization policy concerns from other system aspects, (2) creates an expressive specification notation for utilization policies and (3) creates a policy conflict resolution capability. My approach enables creating specifications of policies that are sufficiently precise and detailed to support static and dynamic analyses of how these policies affect the properties of systems governed by these policies.

I have built a process- and resource-aware discrete-event simulation engine for simulating system executions that adhere to resource specifications. The engine's evaluation of a hospital ED healthcare system demonstrated that it supports considerable flexibility in resource and utilization policy specification and provides powerful dynamic analyses.

Given the simulation's capability, I developed an approach for scheduling the staffing of hospital EDs by integrating simulations with integer linear programming. Because staffing is dependent on the patient-care process, interactions among resources, and other operational constraints, I have developed detailed and precise simulation models for the ED process of caring for patients and for the relevant resources.

My simulation research shows promising results for flexible support of diverse resource decisions and effective dynamic analysis through process- and resource-aware discrete-event simulations. However, the approach is inherently limited because of the impossibility of exhaustive simulations of all scenarios. To complement the simulation approach, I have developed process- and resource-aware static analysis approach. My static analysis approach utilizes powerful model checking techniques, building on the existing FLAVERS model checking tool, to verify properties of complex systems that are also verified to conform to complex resource utilization policies. In doing this, my research demonstrates how my analysis framework can be effective in guiding the domain expert towards sound decisions about policies for the management of hospital resources, while also providing rigorously-based assurances that the guidance is reliable and well-founded.

8.2 Future Work

My case study shows promise that my framework helps system developers evaluate, validate and verify diverse and complex resource utilization policies in a hospital ED system. Related to this case study, my ED models are continuously evolving based on newly observed real-world data and interactions with my domain expert. Therefore, continuous validation through close comparison between real-world data and simulations outputs are required. Concerning verifications, I have verified the adherence to hospital policies of my ED models. However, key functional properties in a hospital ED, that needed to be verified, should be identified.

Some continuations of my research may require long term research. I believe that the following research questions also lead to very interesting research topics related to efficient and effective resource management.

Future research question 1: How does my resource manager guarantee that it always adhere to all the specified resource policies?

I have developed a process- and resource-aware discrete-event simulator by separating a resource management component that adheres to my resource specifications. However, developing software components of a resource manager may create errors that violate my resource utilization policy specifications. Therefore, further research is required to guarantee my resource manager always adheres to all the specified resource policies.

Future research question 2: How can analysts be guided to build resource function properties?

A resource must sometimes follow a sequence of activities while participating in a system. In my approach, this resource function property is satisfied by using a combination of activity coordination and resource utilization policy specifications. Activity coordination constrains a sequence of requests from activities. Resource utilization policies then constrain which resources must be selected for given requests. My approach allows analysts to specify these resource function properties by using a property FSM; however, specifying such property specifications is often difficult for domain experts. Therefore, systematic guidance is required to assist domain experts both identify and define resource function properties.

Future research question 3: How can resource time constraints be included in a static analysis framework?

Static analysis of time constraints is well-known as an important but hard problem. Some resource utilization policies are constrained by time. For example, shift policy in a

hospital ED is directly related to the time of a day. However, FLAVERS, that I use for static resource analysis, does not support time analysis. Therefore, further research to specify time-enriched static analysis models and time-analysis techniques is required to analyze time-related resource utilization policies.

Future research question 4: How do my static and dynamic analyses assure that they follow the same semantic of my resource specifications?

I have implemented behaviors of a resource manager for dynamic and static analysis. These two different versions of implementations are intended to follow the same semantic of my resource specifications. The absence of a proper analysis to verify that both implementations always adhere to the same semantic of resource specifications may threaten the validity of analysis results. Therefore, further research is required to verify the equivalence between different implementations that adhere to the same specifications.

Future research question 5: What aspects should be included to define resources in systems?

My research provides a specification approach to define resource characteristics through attributes (e.g., capacity and effort-needed) and capabilities. Even though the specification approach aims to specify diverse kinds of resources across different domains, many issues remain to be addressed.

A system integrates diverse kinds of components often including resources. In general, a system distinguishes resources from other components based on an intuitive understanding about resources in the system. For instance, a resource is an entity needed to perform an activity in a system. However, an intuitive informal definition likely leads toward limitations in analyzing complex and dynamic resources. Identifying key aspects to precisely define resources in complex systems is a challenging problem. My approach attempts to identify key aspects of resources to support powerful dynamic and static analyses of resource

utilization; however, further evaluations should follow by applying it to other complex systems.

Resources in a system has complex relations with other system components such as activities, artifacts and the resource themselves. My approach handles these relations from the perspective of resource allocations. However, there are many research opportunities investigating the relational aspect of resources. For instance, configuration of resources varies over different phases in system operations such as build, runtime, upgrade, and other phases. Each phase in a system may require and allow different forms of resource configurations. Specifying and analyzing such complex resource relations present interesting problems.

Future research question 6: What aspects should be included to define policies in systems?

My research focuses on resource utilization policies in complex systems and provides a resource-aware specification and analysis framework. In addition to resource utilization policies, systems often incorporate diverse kinds of policies such as access controls, business rules, guidelines, regulations and other policies. All these different policies influence system behaviors by having direct or indirect relations among them. These policies also vary over dynamic contexts such as time and a system's environment. The complexity of policies requires careful analyses to satisfy system requirements. However, it is hard to characterize these policies precisely enough to support analyses.

I characterize resource utilization policies through permission constraints, schedules, and conflict resolution policies. However, this approach should be further evaluated by applying it to other complex systems. In addition, identifying common and various characteristics among other kinds of policies (e.g., access control) across many systems is necessary to understand the nature of policies which eventually allows policy analyses. Clear separation of these policies and tractable interactions among policies and a system are required to support policy analyses such as consistency checks, policy evaluations, and other analyses.

Any inconsistency between policies likely creates a conflict situation in which a system has a problem in delivering its functions as required. There are many kinds of inconsistencies or conflicts exist among diverse policies. In addition, there are different kinds of methods to address each conflict condition. For instance, if two different access control policies enforce a permission and a prohibition to access the same data entity at the same time, this conflict should be avoided before or resolved after the conflict occurs. Different kinds of policies may also create a conflict condition. For example, a resource utilization policy allocates a resource to an activity; however, the resource does not have the authority to access artifacts associated with the activity. Even though my research addresses analysis issues related to resource utilization policies, further research should follow to address the analysis issues concerning diverse policies.

Future research question 7: What are the differences between a model and a real-world system from the perspective of policies?

In general, there are gaps between a model and a real-world system. Modeling activity usually abstracts out unnecessary details in the real-world based on modeling purposes, domain experts' expertise, observed data, and other modeling related factors. For instance, if a hospital administrator wants to evaluate the effects of a new staffing policy by using a simulation, what aspects should be included in a simulation model? In addition, the evaluation of new policy is challenging because there are no oracles for the new policy. The hospital administrator, in this example, needs some kind of supporting evidence that the simulation results are also expected in a real-world implementation of the new policy. The details which were abstracted out may, in fact, greatly influence the real-world system behaviors. A systematic approach to analyze the differences helps a system developer improve policies in complex systems.

Executions in a model and a real-world system are also different. For instance, my analysis framework uses a discrete time clock, interleaving semantics, strict enforcement of policies, and other semantics facilitate my simulations and model checking. However,

a real-world human-intensive system does not exactly follow these semantics. The gap between the different semantics may result in significantly different effects of the policies in the two worlds. For instance, my constraint-aware scheduling approach assumes there are no dramatic changes between discrete time blocks. However, if significantly dramatic changes occur in a real-world system, my approach is not applicable. Developing new semantics or providing exact differences and their consequences may bridge the semantic gap. In both directions, my approach has to be further refined.

BIBLIOGRAPHY

- [1] Affeldt, Reynald, and Kobayashi, Naoki. Formalization and verification of a mail server in coq. In *Proceedings of the 2002 Mext-NSF-JSPS International Conference on Software Security: Theories and Systems* (Berlin, Heidelberg, 2003), ISSS'02, Springer-Verlag, pp. 217–233.
- [2] Ahn, Jeongseob, Kim, Changdae, Han, Jaeung, Choi, Young-Ri, and Huh, Jaehyuk. Dynamic virtual machine scheduling in clouds for architectural shared resources. In *Proceedings of the 4th USENIX Conference on Hot Topics in Cloud Computing* (2012), HotCloud'12, USENIX Association, pp. 19–19.
- [3] Alvarez, Rene, Sandoval, Guillermo A., Quijada, Sergio, and Brown, Adalsteinn D. A simulation study to analyze the impact of different emergency physician shift structures in an emergency department. In *Proceedings of the 35th International Conference on Operational Research Applied to Health Services (ORAHS)* (2009).
- [4] Avrunin, George S., Clarke, Lori A., Osterweil, Leon J., Christov, Stefan C., Chen, Bin, Henneman, Elizabeth A., Henneman, Philip L., Cassells, Lucinda, and Mertens, Wilson. Experience modeling and analyzing medical processes: Umass/baystate medical safety project overview. In *Proceedings of the 1st ACM International Health Informatics Symposium* (New York, NY, USA, 2010), IHI '10, ACM, pp. 316–325.
- [5] Bari, Md. Faizul, Boutaba, Raouf, Esteves, Rafael Pereira, Granville, Lisandro Zambenedetti, Podlesny, Maxim, Rabbani, Md Golam, Zhang, Qi, and Zhani, Mohamed Faten. Data center network virtualization: A survey. *IEEE Communications Surveys and Tutorials*, 2 (2013), 909–928.
- [6] Beck, Ekkehard. A discrete event simulation approach to resource management, process changes and task prioritization in emergency departments. Master's thesis, Department of Mechanical and Industrial Engineering, University of Massachusetts, Amherst, MA, USA, 2009.
- [7] Boyd-Wickizer, Silas, Morris, Robert, and Kaashoek, M. Frans. Reinventing scheduling for multicore systems. In *Proceedings of the 12th Conference on Hot Topics in Operating Systems* (Berkeley, CA, USA, 2009), HotOS'09, USENIX Association, pp. 21–21.
- [8] Brenner, Stuart, Zeng, Zhen, Liu, Yang, Wang, Junwen, Li, Jingshan, and Howard, Patricia K. Modeling and analysis of the emergency department at university of kentucky chandler hospital using simulations. *Journal of Emergency Nursing* 36 (2010), 303–310.

- [9] Burgess, Mark. A site configuration engine. *Computing Systems* 8, 3 (1995).
- [10] Chen, Bin. *Improving Processes Using Static Analysis Techniques*. PhD thesis, University of Massachusetts Amherst, 2010.
- [11] Chlipala, Adam. *Certified Programming with Dependent Types*. MIT Press, 2011. <http://adam.chlipala.net/cpdt/>.
- [12] Clarke, E. M., Emerson, E. A., and Sistla, A. P. Automatic verification of finite-state concurrent systems using temporal logic specifications. *ACM Trans. Program. Lang. Syst.* 8, 2 (Apr. 1986), 244–263.
- [13] Cochran, Jeffery K., and Roche, Kevin T. A multi-class queuing network analysis methodology for improving hospital emergency department performance. *Computers & Operations Research* 36 (2009), 1497–1512.
- [14] Committee Specification. *Ws-bpel extension for people (bpel4people) specification version 1.1*. Tech. rep., OASIS, august 2010.
- [15] Connelly, Lloyd G., and Bair, Aaron E. Discrete event simulation of emergency department activity: A platform for system-level operations research. *Academic Emergency Medicine* 11, 11 (2004), 1177–1185.
- [16] Damianou, Nicodemos C., Bandara, Arosha K., Sloman, Morris S., and Lupu, Emil C. A survey of policy specification approaches. Tech. rep., Department of Computing, Imperial College of Science Technology and Medicine, 2002.
- [17] DeCandia, Giuseppe, Hastorun, Deniz, Jampani, Madan, Kakulapati, Gunavardhan, Lakshman, Avinash, Pilchin, Alex, Sivasubramanian, Swaminathan, Vosshall, Peter, and Vogels, Werner. Dynamo: Amazon’s highly available key-value store. *SIGOPS Oper. Syst. Rev.* 41, 6 (Oct. 2007), 205–220.
- [18] Deshmukh, Jyotirmoy, Emerson, E. Allen, and Sankaranarayanan, Sriram. Symbolic deadlock analysis in concurrent libraries and their clients. In *Proceedings of the 2009 IEEE/ACM International Conference on Automated Software Engineering* (Washington, DC, USA, 2009), ASE ’09, IEEE Computer Society, pp. 480–491.
- [19] Dimoulas, Christos, Moore, Scott, Askarov, Aslan, and Chong, Stephen. Declarative policies for capability control. In *CSF’14* (2014), pp. 3–17.
- [20] Duguay, Christine, and Chetouane, Fatah. Modeling and improving emergency department systems using discrete event simulation. *Simulation* 83, 3 (2007), 311–320.
- [21] Dwyer, Matthew B., Clarke, Lori A., Cobleigh, Jamieson M., and Naumovich, Gleb. Flow analysis for verifying properties of concurrent software systems. *ACM Trans. Softw. Eng. Methodol.* 13, 4 (Oct. 2004), 359–430.
- [22] FlexSim Software Products. FlexSim. <http://www.flexsim.com>.

- [23] Green, L. V., Soares, J., Gjulio, J., and Green, R. Using queuing theory to increase the effectiveness of physician staffing in the emergency department. *Academic Emergency Medicine* (2006).
- [24] Hoagland, James, Pandey, Raju, and Levitt, Karl N. Security policy specification using a graphical approach. Tech. Rep. CSE-98-3, University of California, Davis, 1998.
- [25] Holey, Anup, Mekkat, Vineeth, Yew, Pen-Chung, and Zhai, Antonia. Performance-energy considerations for shared cache management in a heterogeneous multicore processor. *ACM Transactions on Architecture and Code Optimization (TACO)* 12, 1 (2015), 1–29.
- [26] Holzmann, Gerard J. The model checker spin. *IEEE Trans. Softw. Eng.* 23, 5 (May 1997), 279–295.
- [27] Iosif, Radu, Dwyer, Matthew B., and Hatcliff, John. Translating java for multiple model checkers: The bandera back-end. *Form. Methods Syst. Des.* 26, 2 (Mar. 2005), 137–180.
- [28] Jennings, Brendan, and Stadler, Rolf. Resource management in clouds: Survey and research challenges. *Journal of Network and Systems Management* 23 (2015), 567–619.
- [29] Ji, Xiujuan, Yang, Jufeng, Xu, Jing, Feng, Lei, and Li, Xiaohong. Interprocedural path-sensitive resource leaks detection for c programs. In *Proceedings of the Fourth Asia-Pacific Symposium on Internetware* (New York, NY, USA, 2012), Internetware '12, ACM, pp. 19:1–19:9.
- [30] Kagal, Lalana, Finin, Tim, and Joshi, Anupam. A policy language for a pervasive computing environment. In *Proceedings of the 4th IEEE International Workshop on Policies for Distributed Systems and Networks* (Washington, DC, USA, 2003), POLICY '03, IEEE Computer Society, pp. 63–.
- [31] Kwiatkowska, Marta, Norman, Gethin, and Parker, David. Prism 4.0: Verification of probabilistic real-time systems. In *Proceedings of the 23rd International Conference on Computer Aided Verification* (Berlin, Heidelberg, 2011), CAV'11, Springer-Verlag, pp. 585–591.
- [32] Lakshman, Avinash, and Malik, Prashant. Cassandra: A decentralized structured storage system. *SIGOPS Oper. Syst. Rev.* 44, 2 (Apr. 2010), 35–40.
- [33] Lerner, Barbara Staudt, Christov, Stefan, Osterweil, Leon J., Bendraou, Reda, Kanngiesser, Udo, and Wise, Alexander E. Exception handling patterns for process modeling. *IEEE Transactions on Software Engineering* 36, 2 (2010), 162–183.
- [34] Li, Hongchen, Yang, Yun, and Chen, T. Y. Resource constraints analysis of workflow specifications. *J. Syst. Softw.* 73, 2 (Oct. 2004), 271–285.

- [35] Li, Jingshan, and Howard, Patricia K. Modeling and analysis of hospital emergency department: An analytical framework and problem formulation. In *Proceedings of the 6th annual IEEE Conference on Automation Science and Engineering* (Toronto, ON, Canada, August 2010), pp. 897–902.
- [36] Lobo, Jorge, Bhatia, Randeep, and Naqvi, Shamim. A policy description language. In *Proceedings of the Sixteenth National Conference on Artificial Intelligence and the Eleventh Innovative Applications of Artificial Intelligence Conference Innovative Applications of Artificial Intelligence* (Menlo Park, CA, USA, 1999), AAAI '99/IAAI '99, American Association for Artificial Intelligence, pp. 291–298.
- [37] Loveland, Donald W. *Automated Theorem Proving: A Logical Basis (Fundamental Studies in Computer Science)*. sole distributor for the U.S.A. and Canada, Elsevier North-Holland, 1978.
- [38] Martinez, P., Brunner, M., Quittek, J., Strauss, F., Schonwalder, J., Mertens, S., and Klie, T. Using the script mib for policy-based configuration management. In *Network Operations and Management Symposium* (2002), NOMS 2002, IEEE, pp. 187–202.
- [39] Mathew, Vimal, Sitaraman, Ramesh K., and Shenoy, Prashant J. Energy-efficient content delivery networks using cluster shutdown. In *International Green Computing Conference, IGCC 2013, Arlington, VA, USA, June 27-29, 2013, Proceedings* (2013), pp. 1–10.
- [40] MathWorks. SimEvents. <http://www.mathworks.com/products/simevents>.
- [41] McCarthy, M. L., Ding, R., Pines, J. M., and Zeger, S. L. Comparison of methods for measuring crowding and its effects on length of stay in the emergency department. *Academic Emergency Medicine* 18, 12 (2011), 1269–1277.
- [42] Moore, B., Ellesson, E., Strassner, J., and Westerinen, A. Policy core information model – version 1 specification, 2001.
- [43] Naik, Mayur, Park, Chang-Seo, Sen, Koushik, and Gay, David. Effective static deadlock detection. In *Proceedings of the 31st International Conference on Software Engineering* (Washington, DC, USA, 2009), ICSE '09, IEEE Computer Society, pp. 386–396.
- [44] OASIS Standard. Web services business process execution language version 2.0. Tech. rep., OASIS, april 2007.
- [45] OASIS Standard. extensible access control markup language (xacml) version 3.0. Tech. rep., (OASIS), january 2013.
- [46] Object Management Group. Business process model and notation (bpmn) version 2.0. Tech. rep., Object Management Group, jan 2011.

- [47] Paul, Sharoda A., Reddy, Madhu C., and Deflitch, Christopher J. A systematic review of simulation studies investigating emergency department overcrowding. *Simulation* 86, 8-9 (Aug. 2010), 559–571.
- [48] Petriu, Dorin B., and Woodside, Murray. An intermediate metamodel with scenarios and resources for generating performance models from uml designs. *Software & Systems Modeling* 6 (2007), 163–184.
- [49] ProModel. Simio. <http://www.promodel.com>.
- [50] Raunak, Mohammad S. *Resource Management in Complex and Dynamic Environments*. PhD thesis, University of Massachusetts Amherst, 2009.
- [51] Raunak, Mohammad S., and Osterweil, Leon J. Resource management for complex and dynamic environments. *IEEE Transactions on Software Engineering* 39 (2013), 384–402.
- [52] Raunak, Mohammad S., Osterweil, Leon J., Wise, Alexander, Clarke, Lori A., and Henneman, Philip L. Simulating patient flow through an emergency department using process-driven discrete event simulation. In *SEHC* (2009).
- [53] Ribeiro, Carlos, Zúquete, André, Ferreira, Paulo, and Guedes, Paulo. Spl: An access control language for security policies with complex constraints. In *Network and Distributed System Security Symposium* (2001), NDSS'01.
- [54] Rockwell Automation. Arena. <http://www.arenasimulation.com/>.
- [55] Sandhu, Ravi S., Coyne, Edward J., Feinstein, Hal L., and Youman, Charles E. Role-based access control models. *Computer* 29, 2 (Feb. 1996), 38–47.
- [56] SAS. Simulation studio. http://www.sas.com/en_us/software/analytics/simulation-studio.html.
- [57] Sekar, R. C., and Smith, Kevin N. Obj as a theorem prover with applications to hardware verification. In *Current Trends in Hardware Verification and Automated Theorem Proving*, Graham Birtwistle and P. A. Subrahmanyam, Eds. Springer-Verlag New York, Inc., New York, NY, USA, 1989, pp. 218–267.
- [58] Shi, Huiling, Ma, Wenke, Yang, Meihong, and Zhang, Xinchang. A case study of model checking retail banking system with SPIN. *JCP* 7, 10 (2012), 2503–2510.
- [59] Shin, Seung Yeob, Brun, Yuriy, Osterweil, Leon J., Balasubramanian, Hari, and Henneman, Philip L. Resource specification for prototyping human-intensive systems. In *Proceedings of the 18th International Conference on Fundamental Approaches to Software Engineering (FASE)* (London, England, April 2015), pp. 332–346. DOI: 10.1007/978-3-662-46675-9_22.
- [60] Simio LLC. Simio. <http://www.simio.com>.

- [61] Sinreich, David, and Marmor, Yariv. Emergency department operations: The basis for developing a simulation tool. *IIE Transactions* 37, 3 (2005), 233–245.
- [62] Snir, Y., Ramberg, Y., Strassner, J., Cohen, R., and Moore, B. Policy quality of service (qos) information model, 2003.
- [63] Sui, Yulei, Ye, Ding, and Xue, Jingling. Static memory leak detection using full-sparse value-flow analysis. In *Proceedings of the 2012 International Symposium on Software Testing and Analysis* (New York, NY, USA, 2012), ISSTA 2012, ACM, pp. 254–264.
- [64] Torlak, Emina, and Chandra, Satish. Effective interprocedural resource leak detection. In *Proceedings of the 32Nd ACM/IEEE International Conference on Software Engineering - Volume 1* (New York, NY, USA, 2010), ICSE '10, ACM, pp. 535–544.
- [65] van der Aalst, W. M. P., and ter A. H. M. Hofstede. Yawl: Yet another workflow language. *Inf. Syst.* 30, 4 (June 2005), 245–275.
- [66] Wang, Jiacun, and Li, Demin. Resource modeling and analysis for workflows. In *IEEE International Conference on Networking, Sensing and Control* (2012), ICNSC 2012, IEEE, pp. 187–192.
- [67] Wang, Jiacun, and Rosca, Daniela. Dynamic workflow modeling and verification. In *Proceedings of the 18th International Conference on Advanced Information Systems Engineering* (Berlin, Heidelberg, 2006), CAiSE'06, Springer-Verlag, pp. 303–318.
- [68] Wang, Jiacun, Tepfenhart, William, Rosca, Daniela, and Tsai, Anni. Workflow resource requirement modeling and analysis. In *IEEE International Conference on Networking, Sensing and Control* (2008), ICNSC 2008, IEEE, pp. 246–251.
- [69] Wang, Junwen, Li, Jingshan, Tussey, Kathy, and Ross, Kay. Reducing length of stay in emergency department: A simulation study at a community hospital. *IEEE TRANSACTIONS ON SYSTEMS, MAN, AND CYBERNETICS?PART A: SYSTEMS AND HUMANS* 42, 6 (2012).
- [70] Wil van der Aalst and Arthur ter Hofstede. Workflow Patterns. <http://www.workflowpatterns.com/>.
- [71] Williams, Amy, Thies, William, and Ernst, Michael D. Static deadlock detection for java libraries. In *Proceedings of the 19th European Conference on Object-Oriented Programming* (Berlin, Heidelberg, 2005), ECOOP'05, Springer-Verlag, pp. 602–629.
- [72] Wise, Alexander. Little-JIL 1.5 language report. Tech. Rep. 2006–051, Department of Computer Science, University of Massachusetts, Amherst, 2006.
- [73] Wood, Timothy, Ramakrishnan, K. K., Shenoy, Prashant, and van der Merwe, Jacobus. Cloudnet: Dynamic pooling of cloud resources by live wan migration of virtual machines. In *Proceedings of the 7th ACM SIGPLAN/SIGOPS International Conference on Virtual Execution Environments* (2011), VEE '11, ACM, pp. 121–132.

- [74] World Wide Web Consortium. Xpath. <https://www.w3.org/TR/xpath20/>.
- [75] Xu, Chao, Lin, Felix Xiaozhu, Wang, Yuyang, and Zhong, Lin. Automated os-level device runtime power management. In *Proceedings of the Twentieth International Conference on Architectural Support for Programming Languages and Operating Systems* (2015), ASPLOS '15, ACM, pp. 239–252.
- [76] Zeng, Zhen, Ma, Xiaoji, Hu, Yao, Li, Jingshan, and Bryant, Deborah. A simulation study to improve quality of care in the emergency department of a community hospital. *Journal of Emergency Nursing* 38 (2012), 322–328.